



OPERATING INSTRUCTIONS

Electrode Humidifiers
Condair **CP3mini**

Thank you for choosing Condair

Installation date (MM/DD/YYYY):

Commissioning date (MM/DD/YYYY):

Site:

Model:

Serial number:

Proprietary Notice

This document and the information disclosed herein are proprietary data of Condair Group AG. Neither this document, nor the information contained herein shall be reproduced, used, or disclosed to others without the written authorisation of Condair Group AG, except to the extent required for installation or maintenance of recipient's equipment.

Liability Notice

Condair Group AG does not accept any liability due to incorrect installation or operation of the equipment or due to the use of parts/components/equipment that are not authorised by Condair Group AG.

Copyright Notice

© Condair Group AG, All rights reserved.

Misapprehension and Technical modifications reserved

Contents

1	Introduction	4	6	Fault elimination	43
1.1	To the very beginning	4	6.1	Fault indication	43
1.2	Notes on the operating instructions	4	6.2	Malfunction list	44
2	For your safety	6	6.2.1	System faults	44
3	Product Overview	8	6.2.2	Unit faults	45
3.1	Models overview	8	6.3	Notes on fault elimination	47
3.2	Identification of the unit	8	6.4	Resetting the error indication (red LED lights)	47
3.3	Steam humidifier construction	9	6.5	Replacing the backup battery on the control board	48
3.4	Functional description	11	7	Taking out of service/Disposal	49
3.5	Humidification system overview	12	7.1	Taking out of service	49
4	Operation	14	7.2	Disposal/Recycling	49
4.1	Commissioning	14	8	Product specifications	50
4.2	Notes on operation	15	8.1	Technical data	50
4.2.1	Function of the display and operating elements	15	8.2	Wiring diagram Condair CP3mini	51
4.2.2	Remote operating and fault indication	16			
4.2.3	Inspections during operation	16			
4.2.4	Carrying out manual draining	16			
4.3	Taking the unit out of operation	17			
4.4	Overview and operating of the menu	18			
4.5	Interrogation of the operating information in the indication level	19			
4.6	Unit settings	20			
4.6.1	Launching the unit settings menu	20			
4.6.2	Selecting the dialogue language	20			
4.6.3	Control settings	21			
4.6.4	Configuring the capacity limitation	25			
4.6.5	Configuring the On/Off timer	27			
4.6.6	Activating/Deactivating fault current relay operation	28			
4.6.7	Water management settings	28			
4.6.8	Setting the date	30			
4.6.9	Setting the time	31			
4.6.10	Configuring the display and the steam LED	31			
4.7	Diagnostic functions	33			
4.7.1	Interrogation of the malfunction list	33			
4.7.2	Interrogation of unit information	34			
4.7.3	Performing remote relay tests	35			
4.7.4	Performing Module tests	35			
5	Maintenance	36			
5.1	Important notes on maintenance	36			
5.2	Maintenance list	37			
5.3	Removing and installing parts for maintenance	38			
5.3.1	Removal and installation of the steam cylinder	38			
5.3.2	Disassembly and assembly of the components of the water system	40			
5.4	Notes on cleaning the unit components	41			
5.5	Notes on cleaning agents	42			
5.6	Resetting the maintenance indication	42			

1 Introduction

1.1 To the very beginning

We thank you for having purchased the **steam humidifier Condair CP3mini**.

The steam humidifier Condair CP3mini incorporates the latest technical advances and meets all recognized safety standards. Nevertheless, improper use of the Condair CP3mini may result in danger to the user or third parties and/or impairment of material assets.

To ensure a safe, proper, and economical operation of the steam humidifier Condair CP3mini, please observe and comply with all information and safety instructions contained in the present manual as well as the instructions given in the manuals for the components used in the humidification system.

If you have questions, which are not or insufficiently answered in this documentation, please contact your Condair supplier. They will be glad to assist you.

1.2 Notes on the operating instructions

Limitation

The subject of these operating instructions is the steam humidifier Condair CP3mini in its different versions. The various accessories are only described insofar as this is necessary for proper operation of the equipment. Further information on accessories can be obtained in the respective instructions.

These operating instructions are restricted to the **commissioning, operation, servicing and trouble shooting** of the steam humidifier Condair CP3mini and is meant for **well trained personnel being sufficiently qualified for their respective work**.

The operating instructions is supplemented by various separate items of documentation (spare parts list, manuals for accessories, etc.). Where necessary, appropriate cross-references are made to these publications in the operating instructions.

Symbols used in this manual

CAUTION!

The catchword "CAUTION" designates notes in this documentation that, if neglected, may cause **damage and/or malfunction of the unit or other material assets**.



WARNING!

The catchword "WARNING" used in conjunction with the general caution symbol designates safety and danger notes in this documentation that, if neglected, may cause to **injury to persons**.



DANGER!

The catchword "DANGER" used in conjunction with the general caution symbol designates safety and danger notes in this documentation that, if neglected, may lead to **severe injury or even death of persons**.

Safekeeping

Please safeguard these operating instructions in a safe place, where it can be immediately accessed. If the equipment changes hands, the documentation should be passed on to the new operator.

If the documentation gets mislaid, please contact your Condair supplier.

Language versions

These operating instructions are available in various languages. Please contact your Condair supplier for information.

Copyright protection

The present operating instructions are protected under the Copyright Act. Passing-on and reproduction of the manual (or part thereof) as well as exploitation and communication of the contents are prohibited without written permission by the manufacturer. Violation of copyright terms is subject to legal prosecution and arises liability for indemnification.

The manufacturer reserves the right to fully exploit commercial patent rights.

2 For your safety

General

Every person working with the Condair CP3mini must have read and understood the operating instructions before carrying out any work.

Knowing and understanding the contents of these operating instructions is a basic requirement for protecting the personnel against any kind of danger, to prevent faulty operation, and to operate the unit safely and correctly.

All ideograms, signs and markings applied to the unit must be observed and kept in readable state.

Qualification of personnel

All actions described in the present operating instructions (operation, maintenance, etc.) must be carried out only by **well trained and sufficiently qualified personnel authorised by the owner**.

For safety and warranty reasons any action beyond the scope of this manual must be carried out only by qualified personnel authorised by the manufacturer.

It is assumed that all persons working with the Condair CP3mini are familiar and comply with the appropriate regulations on work safety and the prevention of accidents.

This unit may not be used by persons (including children) with reduced physical, sensory or mental abilities or persons with lacking experience and/or knowledge, unless they are supervised by a person responsible for their safety or they received instructions on how to operate the unit.

Children must be supervised to make sure that they do not play with unit.

Intended use

The steam humidifier Condair CP3mini is intended exclusively for **air humidification via a steam distributor approved by the manufacturer** (unit versions **Condair CP3mini PD..**) or **via the integrated ventilation unit** (unit versions **Condair CP3mini PR..**) **within the specified operating conditions** (see chapter 8 "Product specifications"). Any other type of application without the express written consent of the manufacturer is considered as not conforming with the intended purpose and may lead to the Condair CP3mini becoming dangerous.

Operation of the equipment in the intended manner requires **that all the information in these instructions is observed (in particular the safety instructions)**.

Danger that may arise from the unit



DANGER!
Danger of electrical shock!

The Condair CP3mini is mains powered. One may get in touch with live parts when the unit is open. Touching live parts may cause severe injury or danger to life.

Prevention: Before carrying out any work set the Condair CP3mini out of operation as described in chapter 4.3 (switch off the unit, disconnect it from the mains and stop the water supply) and secure the unit against inadvertent power-up.



WARNING!
Hot water vapour - Danger of scalding!

The Condair CP3mini produces hot water vapour. There is danger of scalding when getting in touch with hot water vapour.

Prevention: Do not carry out any work on the steam system during operation (steam lines, steam distributor, etc.). If the steam system is leaky set the Condair CP3mini immediately out of operation as described in chapter 4.3. Correctly seal the steam system before putting the unit into operation again.



WARNING!
Danger of burning!

During operation the components of the steam system (steam cylinder, steam distributor, etc.) get very hot (up to 100 °C). There is danger of burning when touching the hot components.

Prevention: Before carrying out any work on the steam system set the Condair CP3mini out of operation as described in chapter 4.3, then wait until the components have cooled down sufficiently thus preventing danger of burning.

Behaviour in case of danger

If it is suspected that **safe operation is no longer possible**, then the Condair CP3mini should immediately **be shut down and secured against accidental power-up according to chapter 4.3**.

This can be the case under the following circumstances:

- if the Condair CP3mini or its mains cable is damaged
- if the Condair CP3mini is no longer operating correctly
- if connections and/or piping are not sealed

All persons working with the Condair CP3mini must report any alterations to the unit that may affect safety to the owner without delay.

Prohibited modifications to the unit

No modifications must be undertaken on the Condair CP3mini without the express written consent of the manufacturer.

For the replacement of defective components use exclusively **original accessories and spare parts** available from your Condair supplier.

3 Product Overview

3.1 Models overview

Steam air humidifiers Condair CP3mini are available in the two basic versions for **duct air humidification and direct room air humidification** with **different heating voltages** and **steam capacities of 2 kg/h and 4 kg/h**.

	Model Condair CP3mini			
	Duct		Room	
	PD2	PD4	PR2	PR4
Max. steam capacity	2 kg/h	4 kg/h	2 kg/h	4 kg/h
Heating voltages	230V1~ / 50..60Hz 240V1~ / 50..60Hz 200V2~ / 50..60Hz			
Integrated ventilation unit	—		X	
Display and control unit	X			
External On/Off control	X			
External P/PI control	X			
Internal P/PI controller	X			
Admissible control signals	0–5V, 1–5V, 0–10V, 2–10V, 0–16V, 3.2–16V, 0–20mA, 4–20mA			
Operating parameter	configurable via control software			

3.2 Identification of the unit

The identification of the unit is found on the type plate (for the location of the type plate see unit overview):

	Type designation	Serial number (7 digits)	Month/Year
Heating voltage	Condair Group AG, Gwattstrasse 17, 8808 Pfäffikon SZ, Switzerland		
Maximum steam capacity	Type: CP3mini PD4	Ser.Nr.: XXXXXXX	06.09
Admissible water supply pressure	Heating Voltage: 230V / 1~ / 50...60Hz	Power: 3.1 kW / 13.5 A	
Field with certification symbols	Steam Capacity: 4.0 kg/h	Ctrl.Voltage: 230V / 1~ / 50...60Hz	
Power consumption	Water Pressure: 1...10 bar		
Control voltage			
	Engineered in Switzerland, Made in Germany		

3.3 Steam humidifier construction

Construction Condair CP3mini PD2/PD4

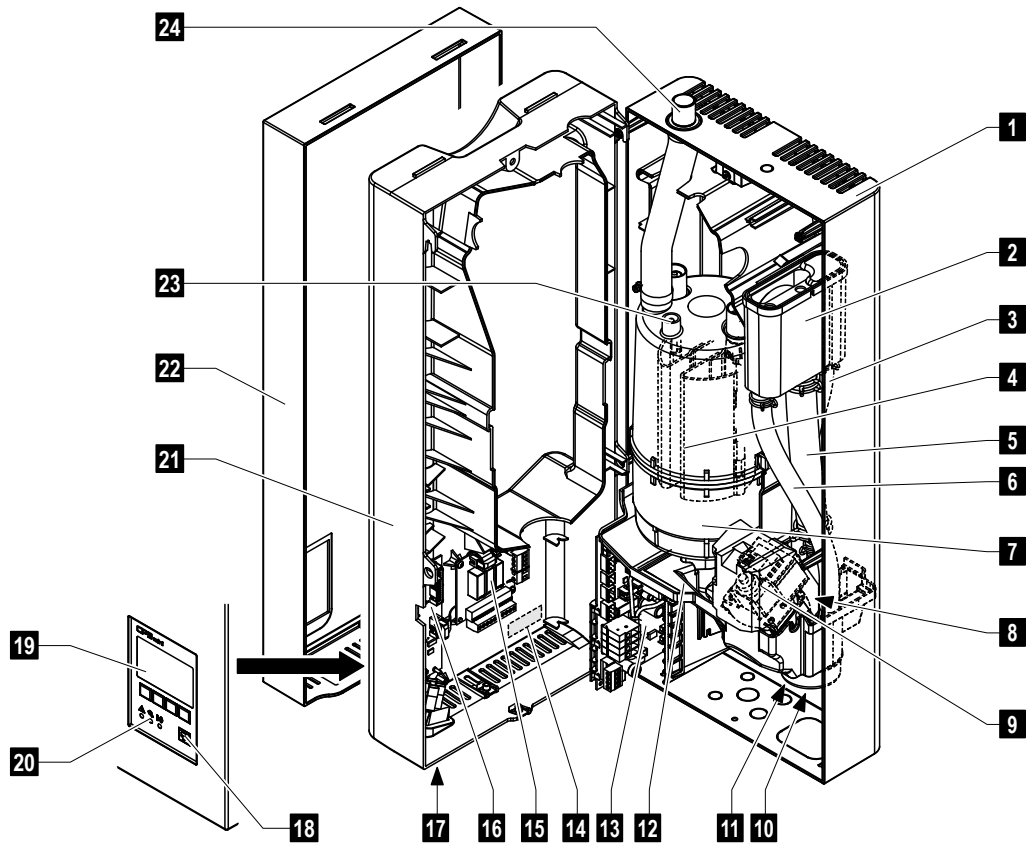

- | | | | |
|----|--------------------------------------|----|--|
| 1 | Back panel | 14 | Type plate |
| 2 | Water cup | 15 | Remote operating and fault indication board (Option) |
| 3 | Water supply hose | 16 | Control board with CF card |
| 4 | Heating electrodes | 17 | Unit switch |
| 5 | Filling hose | 18 | Drain key |
| 6 | Overflow hose | 19 | Display and control unit |
| 7 | Steam cylinder | 20 | Operation status indicators (LED's) |
| 8 | Inlet valve (not visible) | 21 | Intermediate panel |
| 9 | Drain pump | 22 | Front cover |
| 10 | Water drain connector (not visible) | 23 | Level sensor |
| 11 | Water supply connector (not visible) | 24 | Steam outlet connector |
| 12 | Tub | | |
| 13 | Power board | | |

Construction Condair CP3mini PR2/PR4

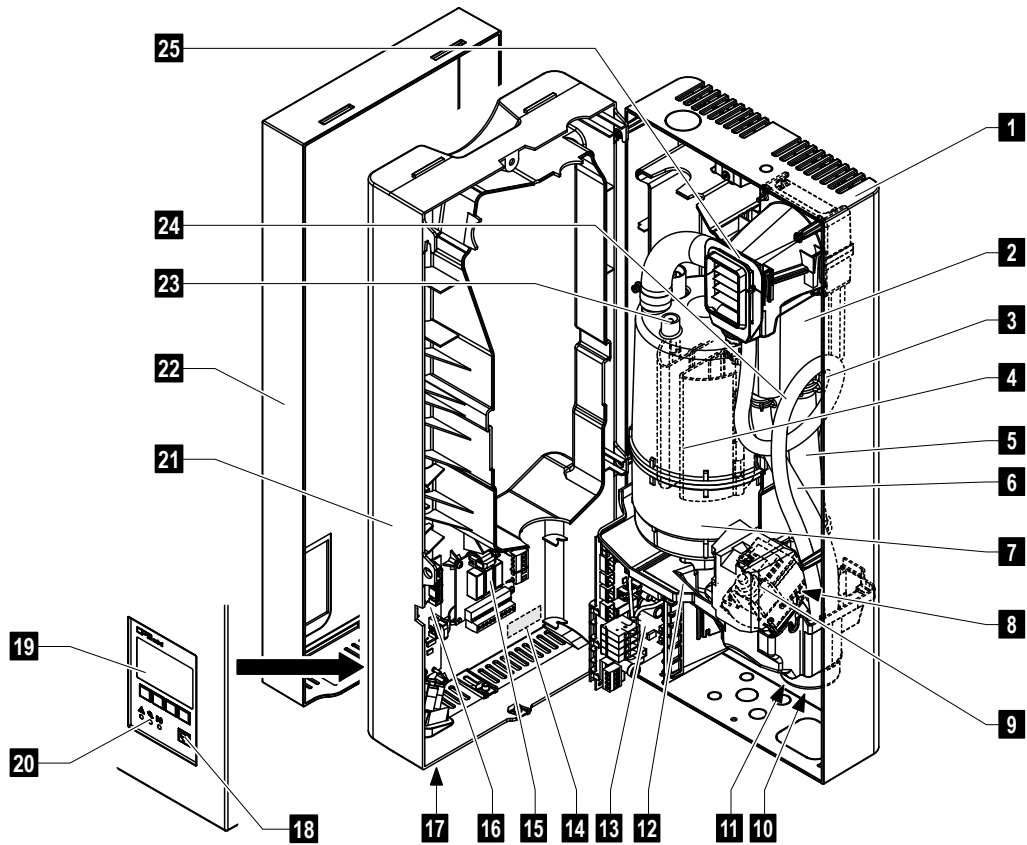

- | | | | |
|----|--------------------------------------|----|--|
| 1 | Back panel | 14 | Type plate |
| 2 | Water cup | 15 | Remote operating and fault indication board (Option) |
| 3 | Water supply hose | 16 | Control board with CF card |
| 4 | Heating electrodes | 17 | Unit switch |
| 5 | Filling hose | 18 | Drain key |
| 6 | Overflow hose | 19 | Display and control unit |
| 7 | Steam cylinder | 20 | Operation status indicators (LED's) |
| 8 | Inlet valve (not visible) | 21 | Unit intermediate panel |
| 9 | Drain pump | 22 | Front cover |
| 10 | Water drain connector (not visible) | 23 | Level sensor |
| 11 | Water supply connector (not visible) | 24 | Condensate hose |
| 12 | Tub | 25 | Ventilation unit |
| 13 | Power board | | |

3.4 Functional description

The steam humidifier Condair CP3mini is a pressureless steam generator that utilizes an electrode heating. The steam humidifier Condair CP3mini is designed for air humidification via a steam distributor (unit versions Condair CP3mini PD..) or via the integrated ventilation unit (unit versions Condair CP3mini PR..).

Steam generation

Any time steam is requested, the electrodes are supplied with voltage. Simultaneously, the inlet valve opens and water enters the steam cylinder from the bottom via water cup and supply line. As soon as the electrodes come in contact with the water, current begins to flow between the electrodes, eventually heating and evaporating the water. The more the electrode surface is exposed to water, the higher is the current consumption and thus the steam capacity.

Upon reaching the requested steam capacity, the inlet valve closes. If the steam generation decreases below a certain percentage of the required capacity, due to lowering of the water level (e.g. because of the evaporation process or drainage), the inlet valve opens until the required capacity is available again.

If the required steam capacity is lower than the actual output, the inlet valve is closed until the desired capacity is achieved by lowering of the water level (evaporation process).

Level monitoring

A sensor provided in the steam cylinder cover detects when the water level gets too high. The moment the sensor comes in contact with water, the inlet valve closes.

Drainage

As a result of the evaporation process, the conductivity of the water increases due to an escalating mineral concentration. Eventually, an inadmissibly high current consumption would take place if this concentration process were permitted to continue. To prevent this concentration from reaching a value, unsuitably high for the operation, a certain amount of water is periodically drained from the cylinder and replaced by fresh water.

Control

The steam production can be controlled steplessly via the internal or an external continuous controller or with an On/Off control via an external humidistat.

3.5 Humidification system overview

System overview Condair CP3mini PD2/PD4

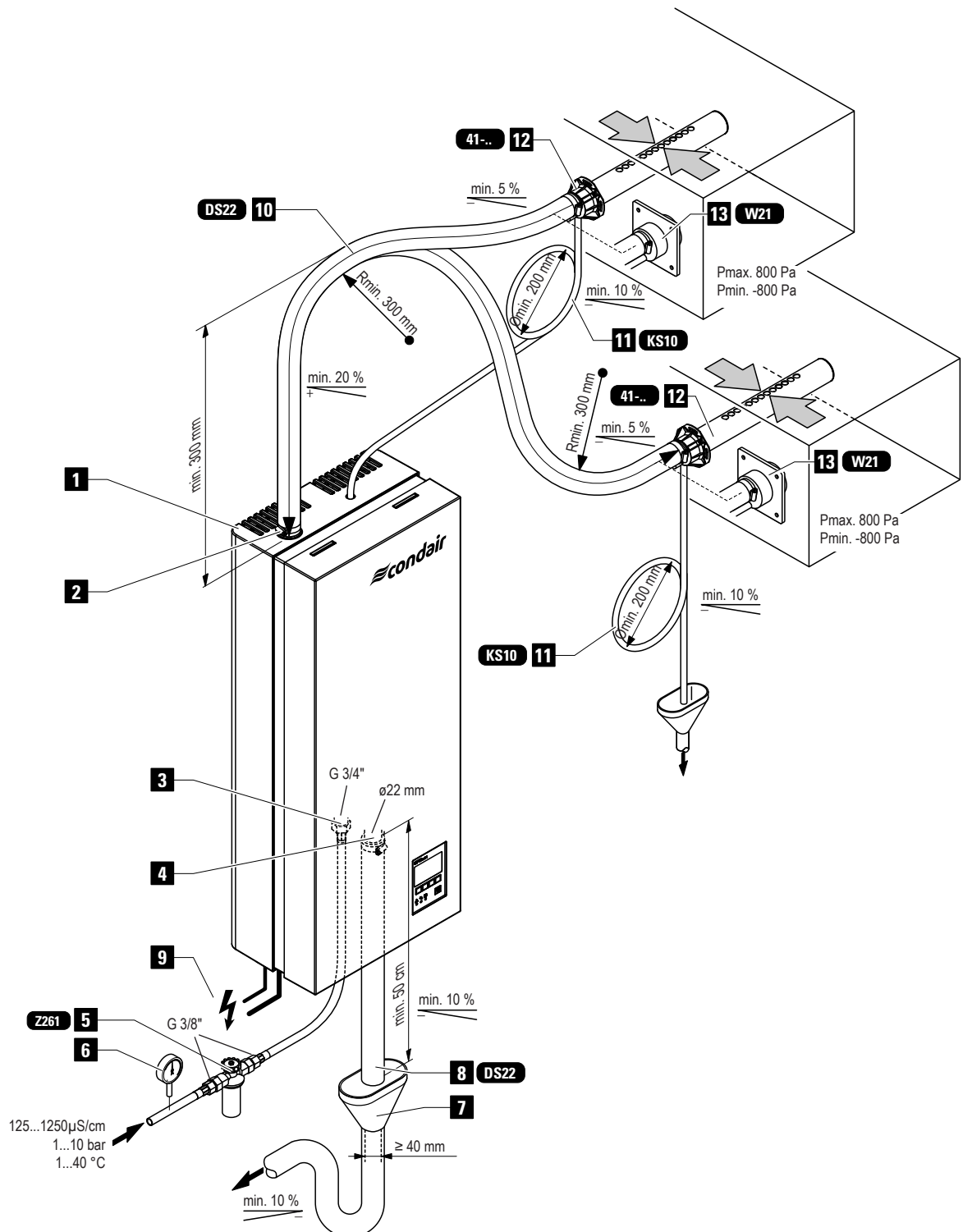

- | | | | |
|---|--------------------------------------|----|--|
| 1 | Steam humidifier | 8 | Water drain hose (accessory "DS22") |
| 2 | Steam connector | 9 | Connecting cables |
| 3 | Water supply connector | 10 | Steam hose (accessory "DS22") |
| 4 | Water drain connector | 11 | Condensate hose (accessory "KS10") |
| 5 | Filter valve (accessory "Z261") | 12 | Steam distribution pipe (accessory "41-...") |
| 6 | Manometer (installation recommended) | 13 | Steam nozzle (accessory "W21") |
| 7 | Funnel with siphon (building side) | | |

System overview Condair CP3mini PR2/PR4

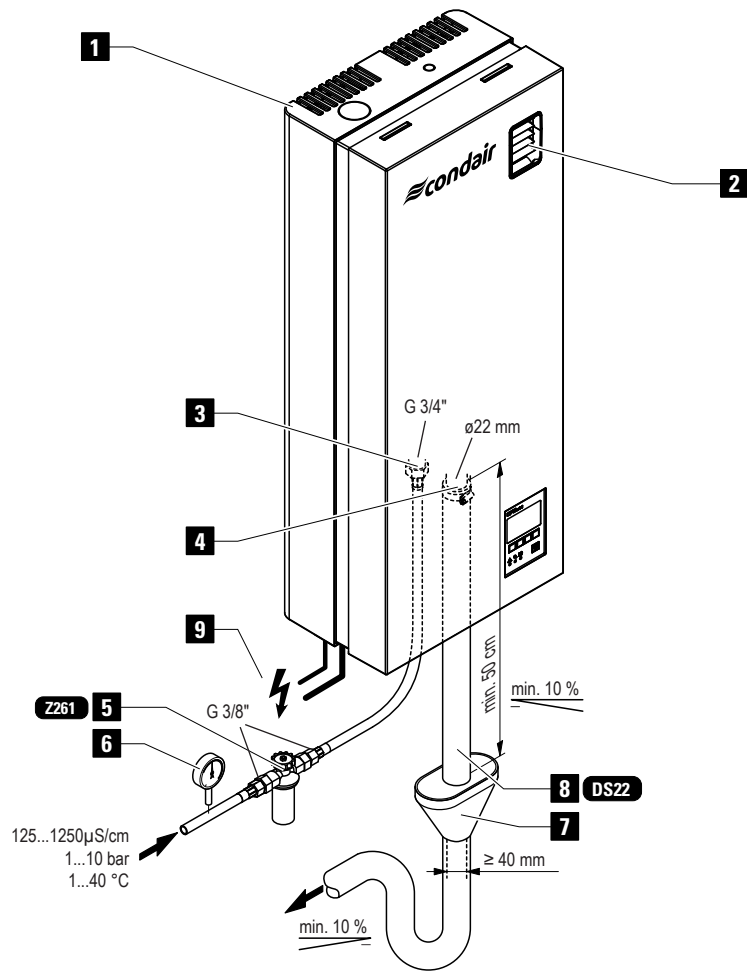

- | | |
|-----------------------------------|--|
| 1 Steam humidifier | 6 Manometer (installation recommended) |
| 2 Ventilation unit | 7 Funnel with siphon (building side) |
| 3 Water supply connector | 8 Water drain hose (accessory "DS22") |
| 4 Water drain connector | 9 Connecting cables |
| 5 Filter valve (accessory "Z261") | |

4 Operation

4.1 Commissioning

Proceed as follows when putting the unit into operation:

1. **Examine the steam humidifier and installation for possible damage.**



DANGER!

Damaged devices or devices with damaged installation may present danger to human life or cause severe damage to material assets.

Damaged units and/or units with damaged or faulty installation must not be operated.

2. Check whether the front panel is mounted and fixed with the screw.
3. Open the **filter valve** (or the shut-off valve, respectively) in the water supply line.
4. Verify the set humidity value at the humidity controller or at the humidistat, and readjust as required.
5. **Switch on the service switch** for mains supply.
6. **Actuate the unit switch** of the steam humidifier. **Switch lights up.**



The steam humidifier carries out a **system test**, during which all the LEDs light up and the opposite display is shown.

If a failure occurs on the system test, a corresponding error message is shown in the display.

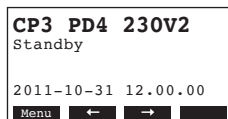

After the system test the unit is in **normal operation mode**. The display shows the **standard operating display** (first page of the indication level). Note: The contents of the standard operating display depends on the actual operating status and on the configuration of the Condair CP3mini and can differ from the opposite display.

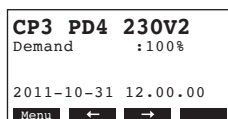

As soon as the humidity controller or the humidistat requires humidity, power is switched on for heating. The inlet valve opens (slight delay) and the steam cylinder fills with water. As soon as the submerged electrodes heat the water up the green LED lights up and after a few minutes (approx. 5–10 minutes, depending on the conductivity of the water) steam is produced.

Note: If the Condair CP3mini is operated with water of low conductivity it may happen that the maximum steam capacity is not reached in the first few hours of operation. This is normal. As soon as the conductivity has reached a sufficient level (due to the vaporisation process) the humidifier will reach the maximum steam capacity.

4.2 Notes on operation

4.2.1 Function of the display and operating elements

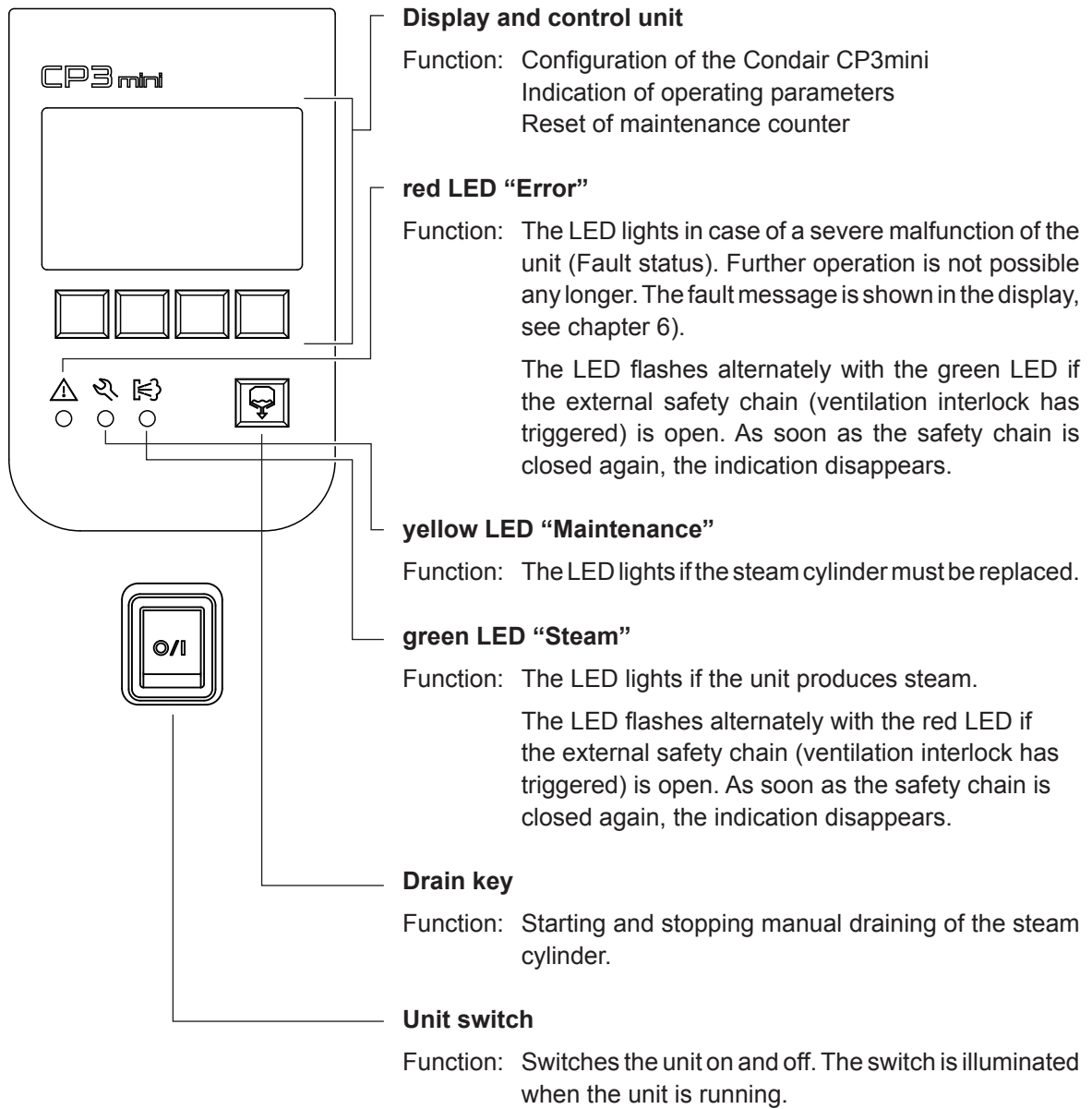

4.2.2 Remote operating and fault indication

If your unit is equipped the optional remote operating and fault indication PCB the following operating status are shown remotely:

Activated remote indication relay	When?	Display on unit
“Error”	A error is present, further operation is normally not possible any longer, the heating voltage is interrupted.	Red LED lights and an error message is shown in the display.
“Service”	The steam cylinder is spent and must be replaced. The unit remains operational for a certain time.	Yellow LED lights and the service warning message is shown in the display.
“Steam”	Steam demand/Steam production	Green LED lights and the standard operating display is shown.
“Unit on”	Unit is switched on.	Unit switch lights and the standard operating display is shown.

4.2.3 Inspections during operation

During operation the Condair CP3mini and the humidification system have to be inspected weekly. On this occasion check the following:

- the water and steam installation for any leakage.
- the steam humidifier and the other system components for correct fixing and any damage.
- the electric installation for any damage.

If the inspection reveals any irregularities (e.g. leakage, error indication) or any damaged components take the Condair CP3mini out of operation as described in chapter 4.3. Then, contact your Condair representative.

4.2.4 Carrying out manual draining

Proceed as follows to drain the unit manually:



Briefly press the drain key.

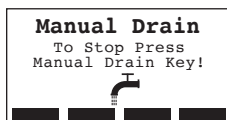

The heating voltage is interrupted and the drain pump starts. As long as the manual drain cycle is in progress the three LED light up successively.

To stop the drain cycle press the **drain key** again.

4.3 Taking the unit out of operation

In order to take the Condair CP3mini out of operation, perform the following steps:

1. If the unit has to be switched off because of a malfunction, please note the error code of the actual error message shown in the display.
2. Close the shut-off valve in the water supply line
3. Start manual draining (see chapter 4.2.4) and wait until the steam cylinder is empty.
4. Actuate the unit switch on the bottom of the unit.
5. **Disconnect steam humidifier from the mains:** Switch off the service switch to mains supply and secure the switch in "off" position against accidentally being switched on, or clearly mark the switch.



WARNING!
Danger of burning!

If steam was produced just before the unit is taken out of operation, wait before opening the unit and let the steam cylinder cool down to prevent danger of burning.

4.4 Overview and operating of the menu

Operating

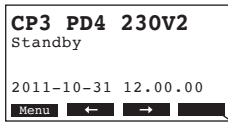

The operating and display unit is operated via the four keys located just below the display. The 4 status fields at the bottom of the display show the active keys the functions assigned to them.

actual key setting



keys

Menu overview

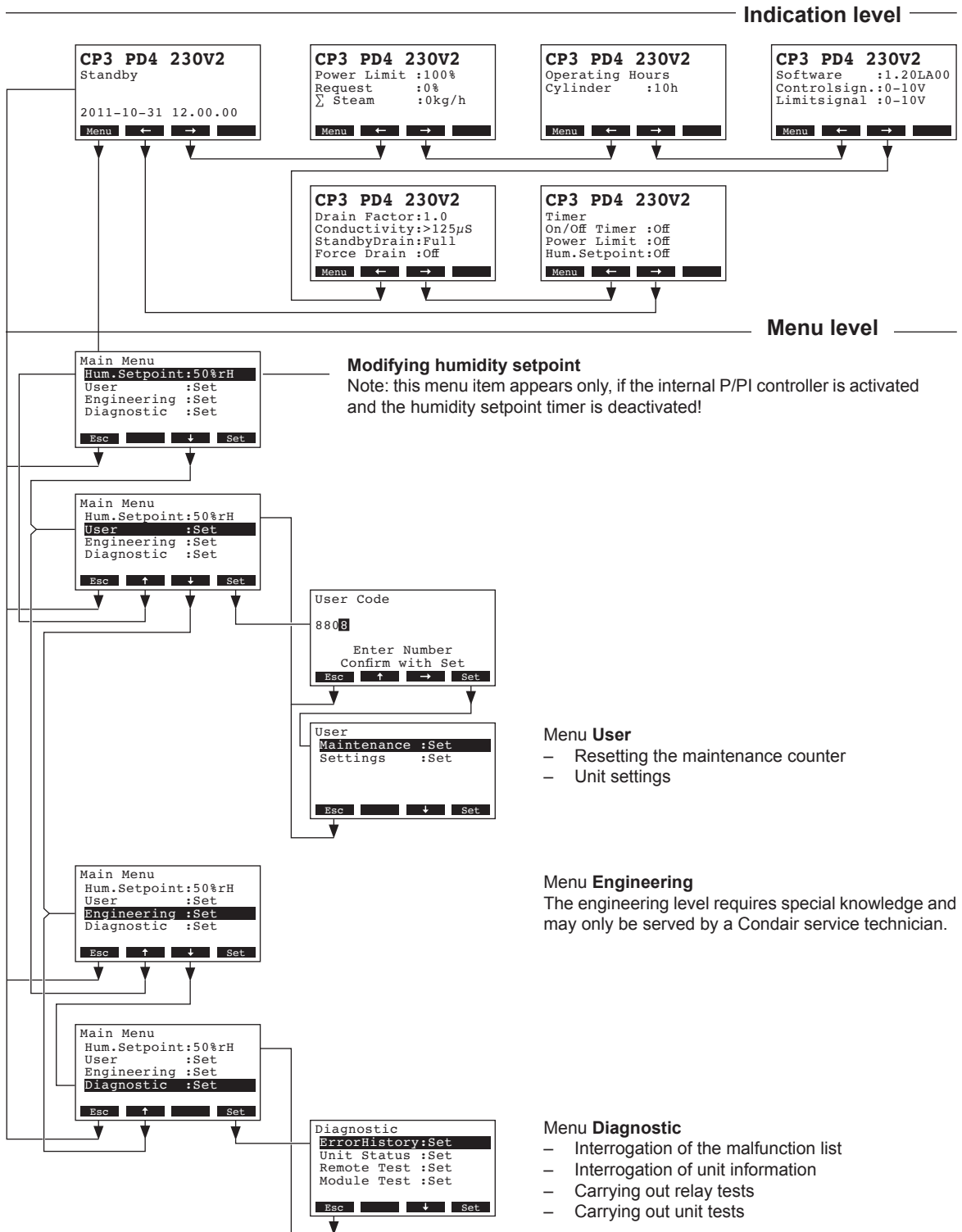

4.5 Interrogation of the operating information in the indication level

In the normal operating mode the operating and display unit is in the indication level. The indication level forms a loop that includes several pages holding operating information which can be accessed with the arrow keys. The various displays of the indication level are shown below.

Info page 1: standard operating display

The appearance of the standard operating display depends on the actual operating status and the configuration of the Condair CP3mini. The following displays are possible.

Note: if the optional radio humidity sensor and/or the "Time-Off" function for the steam LED is/are activated the sensor symbol and/or the crossed out LED symbol is/are shown in the upper right corner of the standard operating display.

```
CP3 PD4 230V2 
Demand      :50%
Limiter      :80%
2011-10-31 12.00.00
Menu  ←  →
```

Standard operating display with control via the **external** controller

- Standby (no humidity demand) or Demand % (humidity demand present)
- Set supply air limitation in % *

* this parameter appears only if external supply air limitation is activated

```
CP3 PD4 230V2 
Act.Humidity: 75%rH
Hum.Setpoint: 50%rH
Lim.Humidity: 60%rH
Lim.Range   : 70-90%
Menu  ←  →
```

Standard operating display with control via the **internal** controller

- Actual humidity in %rh
- Set nominal humidity %rh
- Set supply air limitation in % **
- Set range for supply air limitation in % **

** these parameters appear only if internal supply air limitation is activated

Info page 2: performance data

```
CP3 PD4 230V2
Power Limit :100%
Demand      :0%
Σ Steam     :0.0kg/h
Menu  ←  →
```

- Set power limitation in % of the maximum capacity
- Actual humidity demand in % of the maximum capacity
- Actual steam capacity of the unit in kg/h

Info page 3: operating hours

```
CP3 PD4 230V2
Operating Hours
Cylinder      :40h
Menu  ←  →
```

- Operating hours since the last reset.

Info page 4: settings

```
CP3 PD4 230V2
Software     :1.20LA00
Controlsign :0-10V
Limitsignal  :0-10V
Menu  ←  →
```

- Software version (1.20)/language version (LA00)
- Set control signal range (signal Y) or radio humidity sensor
- Set control signal range for the supply air limitation (signal Z). Appears only if supply air limitation is activated.

Info page 5: drain settings

```
CP3 PD4 230V2
Drain Factor:1.0
Conductivity:>125µS
StandbyDrain:Full
Force Drain :Off
Menu  ←  →
```

- Set drain factor
- Conductivity of the water
- Set draining type in standby operation
- Set time interval for forced draining

Info page 6: timer settings

```
CP3 PD4 230V2
Timer
On/Off Timer :Off
Power Limit  :Off
Hum.Setpoint :Off
Menu  ←  →
```

- Actual status of On/Off timer
- Actual status of power limit timer
- Actual status of humidity setpoint timer (appears only if internal P/PI controller is activated)

4.6 Unit settings

4.6.1 Launching the unit settings menu

Select the unit settings menu:

Path: **Main menu > User > Password entry: 8808 > Settings**

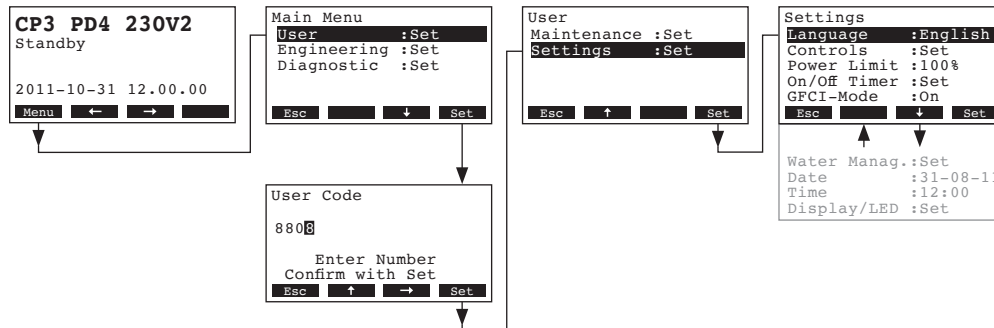

Press the <↓> and <↑> keys in order to select the individual settings in the settings menu. Detailed information on the different settings are found in the following chapters.

4.6.2 Selecting the dialogue language

Select “Language” in the settings menu, then press the <Set> key.

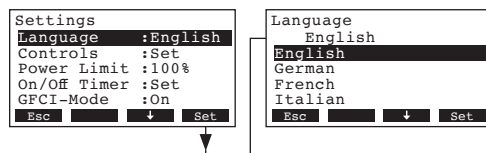

In the upcoming modification dialogue select the desired dialogue language. After confirmation, the unit automatically switches to the selected dialogue language.

Factory setting: **country specific**
Options: **divers languages**

4.6.3 Control settings

Select “**Controls**” in the settings menu, then press the <Set> key.

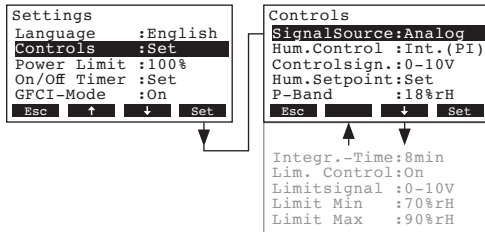

The control settings appear. The settings available depend on the selected signal source and the control type. The above display shows the maximum number of settings available. Informations regarding the individual settings can be found in the following chapters.

4.6.3.1 Selecting the signal source

Note: The setting “SignalSource” appears only if a receiver modul for the optional radio humidity sensor is installed in the Condair CP3mini.

Select “**SignalSource**” in the control settings menu, then press the <Set> key.

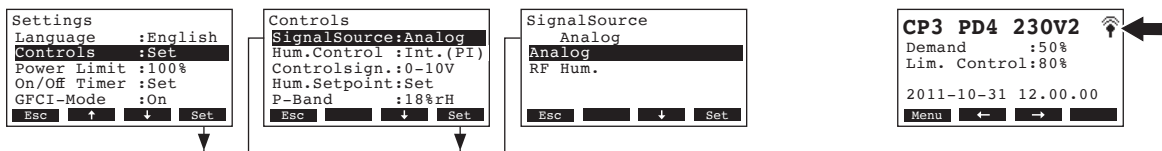

In the upcoming modification dialogue select the desired signal source.

Factory setting: **Analog**

Options: **Analog** or **RF Hum.** (if the optional radio humidity sensor is used)

Note: if “RF Hum.” is selected as signal source (optional radio humidity sensor), the sensor symbol is shown in the upper right corner of the standard operating display afterwards (see the most right display above).

4.6.3.2 Selecting the control type

Select “**Hum.Control**” in the control settings menu, then press the <Set> key.

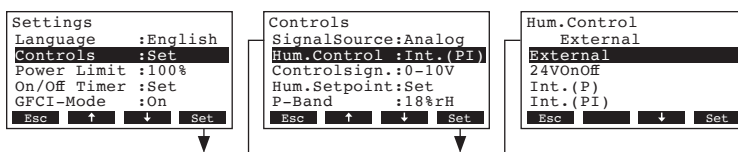

In the upcoming modification dialogue select the desired control type.

Factory setting: **External**

Options: **External** (external continuous controller),
24VOn/Off (external On/Off humidistat),
Int. (P) (Internal P controller)
Int. (PI) (Internal PI controller)

4.6.3.3 Selecting the control signal

Note: This setting is available only if the signal source is set to “Analog” and the control type is set to “External”, “Int. (P)” or “Int. (PI)”.

Select “**Controlsign.**” in the control settings menu, then press the <Set> key.

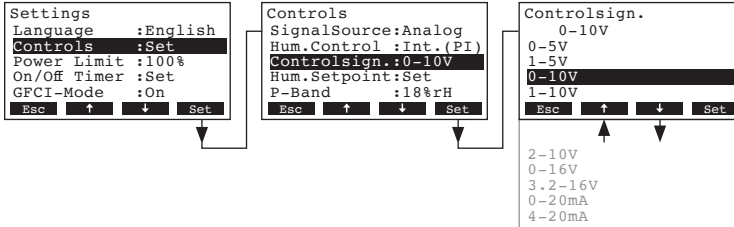

In the upcoming modification dialogue select the desired control signal.

Factory setting: **0-10V**
 Options: **0-5V, 1-5V, 0-10V, 2-10V, 0-16V, 3.2-16V, 0-20mA, 4-20mA**

4.6.3.4 Set the radio address of the optional radio humidity sensor

Note: This setting is available only if the signal source is set to “RF Hum.”

Select “**RF Hum. Addr**” in the control settings menu, then press the <Set> key.

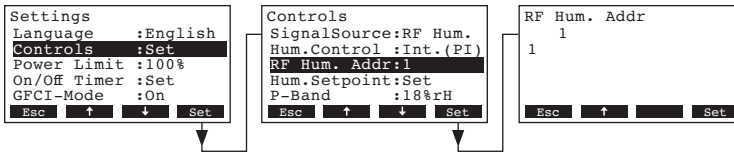

In the upcoming modification dialogue set the radio address of the optional radio humidity sensor.
 Note: Please refer to the separate instruction manual for detailed information regarding the radio humidity sensor.

4.6.3.5 Configuring humidity setpoint

Note: This menu item is available only if the internal P or PI controller is activated.

With the parameters in the “Hum.Setpoint” submenu you determine whether the Condair CP3mini is to be controlled with a fix humidity setpoint (factory setting) or whether it is to be operated timer controlled with different humidity setpoints.

- Control with **fix humidity setpoint**:

Select “**Hum.Setpoint**” in the control settings menu, then press the <Set> key.

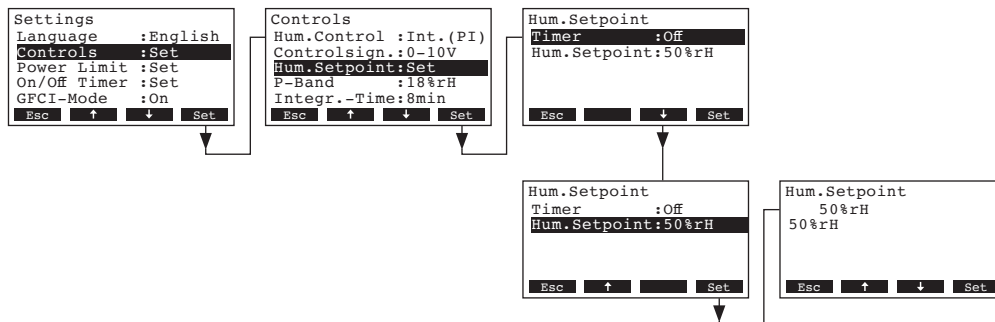

Let the timer deactivated (Off) or deactivate the timer if necessary. Select “**Hum.Setpoint**”, then press the <Set> key. In the upcoming modification dialogue set the value for the fix humidity setpoint (Factory setting: 50 %rh, Setting range: 15...95 %rh).

– **Timer controlled with different humidity setpoints:**

Select “Hum.Setpoint” in the control settings menu, then press the <Set> key.

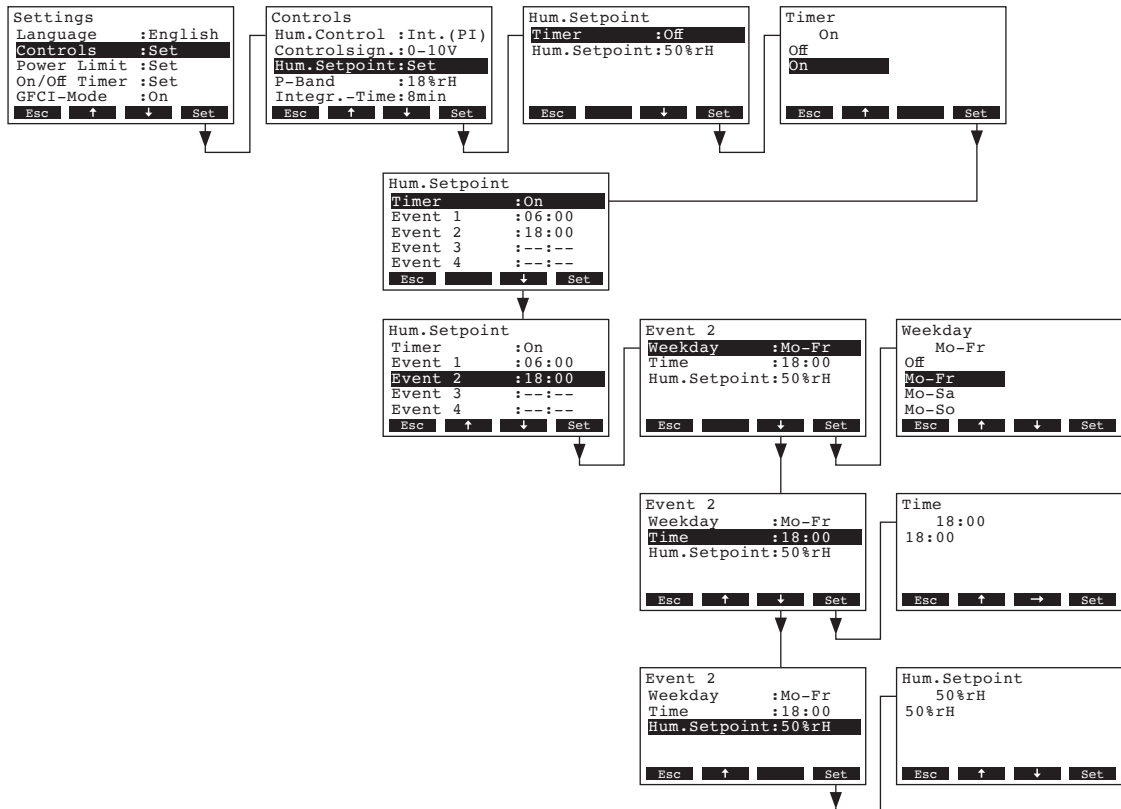

Select “Timer”, then press the <Set> key. In the upcoming modification dialogue activate the timer function and confirm the setting with the <Set> key.

If the timer is activated, up to eight switching points (events 1 - 8) with different humidity setpoints can be defined. Each switching point is defined by a weekday or weekday range, the switching point and the humidity setpoint.

Configuration notes:

- the settings of an event remain active up to the next event.
- the software does not check the plausibility of the timer settings. Therefore, make sure your settings make sense.
- the On/Off timer (see chapter 4.6.5) overrides the humidity setpoint timer.

4.6.3.6 Setting the proportional range for the internal P/PI controller

Note: This menu item is available only if the internal P or PI controller is activated.

Select “P-Band” in the control settings menu, then press the <Set> key.

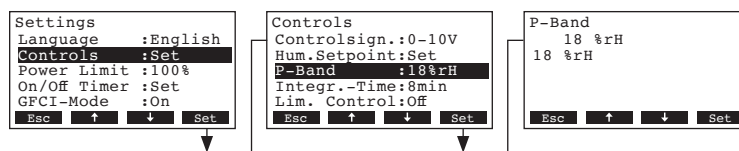

In the upcoming modification dialogue set the proportional range in % for the internal P/PI controller.

Factory setting: **18 %**
Options: **6...65 %**

4.6.3.7 Setting the integral time for the internal PI controller

Note: This setting is available only if the internal PI controller is activated.

Select “**Integr.-Time**” in the control settings menu, then press the <Set> key.

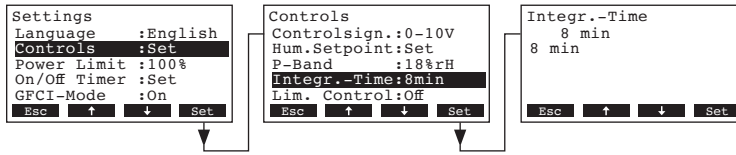

In the upcoming modification dialogue set the integral time in minutes for the internal PI controller.

Factory setting: **8 minutes**

Options: **1...60 minutes**

4.6.3.8 Activating/Deactivating the supply air limitation

Note: This setting is available only if the control type is set to “External”, “Int. (P)” or “Int. (PI)”.

Select “**Lim. Control**” in the control settings menu, then press the <Set> key.

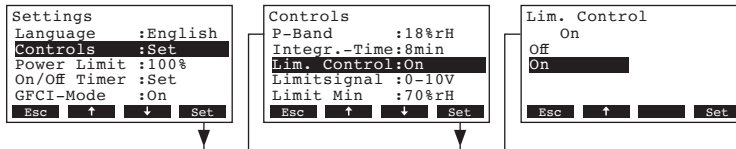

In the upcoming modification dialogue activate or deactivate the supply air limitation (**Signal Z**).

Factory setting: **Off**

Options: **On, Off**

4.6.3.9 Selecting the supply air limitation signal

Note: This setting is available only if the external controller or the internal P or PI controller and the supply air limitation are activated.

Select “**Limitsignal**” in the control settings menu, then press the <Set> key.

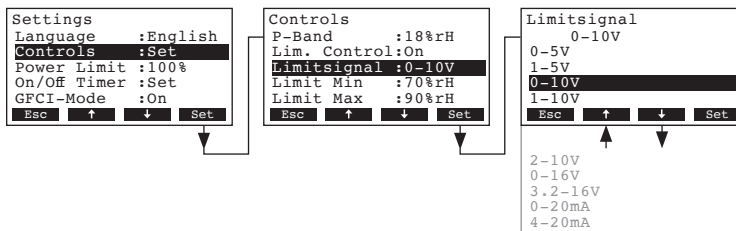

In the upcoming modification dialogue select the desired supply air limitation signal.

Factory setting: **0-10V**

Options: **0-5V, 1-5V, 0-10V, 2-10V, 0-16V, 3.2-16V, 0-20mA, 4-20mA**

4.6.3.10 Setting the lower limit value for the supply air limitation

Note: This setting is available only if the external controller or the internal P or PI controller and the supply air limitation are activated.

Select “**Limit Min**” in the control settings menu, then press the <Set> key.

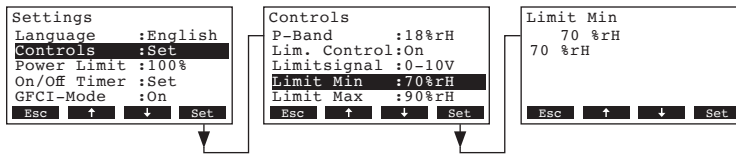

In the upcoming modification dialogue set the lower limit value in %rh for the supply air limitation.

Factory setting: **70 %rh**
Options: **15 ... 95 %rh**

4.6.3.11 Setting the upper limit value for the supply air limitation

Note: This setting is available only if the external controller or the internal P or PI controller and the supply air limitation are activated.

Select “**Limit Max**” in the control settings menu, then press the <Set> key.

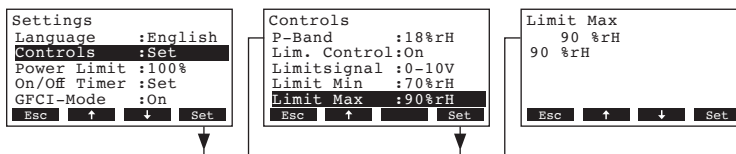

In the upcoming modification dialogue set the upper limit value in %rh for the supply air limitation.

Factory setting: **90 %rh**
Options: **15 ... 95 %rh**

4.6.4 Configuring the capacity limitation

With the parameters in the “Power Limit” submenu you determine whether the Condair CP3mini is to be operated with a fix capacity limit (factory setting) or whether it is to be operated with a timer controlled capacity limitation.

Note: set the desired capacity limitation **in % of the maximum capacity** of the humidifier.

- Operation with **fix capacity limit**:

Select “**Power Limit**” in the settings menu, then press the <Set> key.

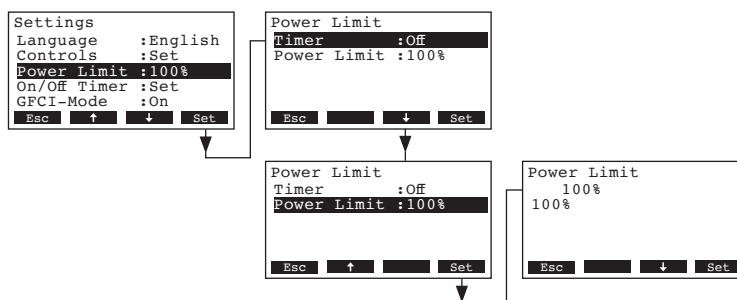

Let the timer deactivated (Off) or deactivate the timer if necessary. Select “**Power Limit**”, then press the <Set> key. In the upcoming modification dialogue set the value for the fix capacity limitation (Factory setting: 100 %, Setting range: 4kg/h unit: 30-100 %, 2kg/h unit: 50-100 %).

– Operation with **timer controlled capacity limitation**:

Select **"Power Limit"** in the settings menu, then press the **<Set>** key.



Select **"Timer"**, then press the **<Set>** key. In the upcoming modification dialogue activate the timer function and confirm the setting with the **<Set>** key.

If the timer is activated, up to eight switching points (events 1 - 8) with different capacity limits can be defined. Each switching point is defined by a weekday or weekday range, the switching point and the capacity limit.

Configuration notes:

- the settings of an event remain active up to the next event.
- the software does not check the plausibility of the timer settings. Therefore, make sure your settings make sense.
- the On/Off timer (see chapter 4.6.5) overrides the capacity limit timer.

4.6.5 Configuring the On/Off timer

With the parameters in the “On/Off Timer” submenu you determine whether or not (factory setting) the Condair CP3mini is to be switched on and off timer controlled.

– Deactivate On/Off timer:

Select “On/Off Timer” in the settings menu, then press the <Set> key. Let the timer deactivated (Off) or deactivate the timer if necessary.

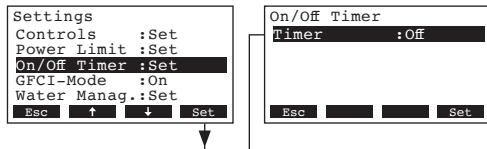

– Activate and configure On/Off timer:

Select “On/Off Timer” in the settings menu, then press the <Set> key.

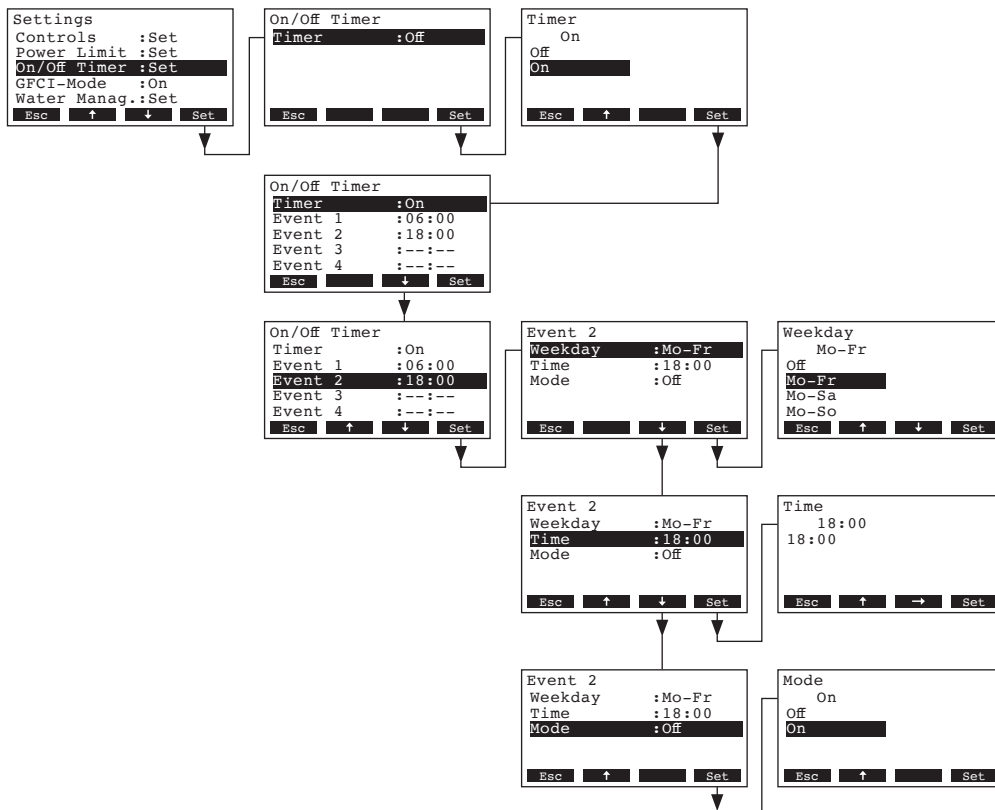

Select “Timer”, then press the <Set> key. In the upcoming modification dialogue activate the timer function and confirm the setting with the <Set> key.

If the timer is activated, up to eight switching points (events 1 - 8) with different On/Off events can be defined. Each switching point is defined by a weekday or weekday range, the switching point and the operating mode.

Configuration notes:

- the settings of an event remain active up to the next event.
- the software does not check the plausibility of the timer settings. Therefore, make sure your settings make sense.
- the On/Off timer overrides all other timers.

4.6.6 Activating/Deactivating fault current relay operation

Select “**GFCI-Mode**” in the settings menu, then press the <Set> key.

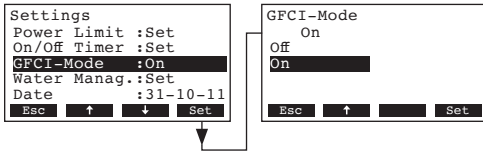

In the upcoming modification dialogue select whether or not the Condair CP3mini is connected to a fault current relay protected mains supply.

Factory setting: **On**
 Options: **On** (mains supply with fault current relay protection)
Off (mains supply without fault current relay protection)

4.6.7 Water management settings

Select “**Water Manag.**” in the settings menu, then press the <Set> key.

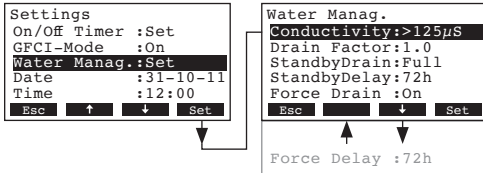

The water management settings appear. Press the <↓> and <↑> keys in order to select the individual settings. Detailed information on the different settings are found in the following chapters.

4.6.7.1 Selecting the conductivity range of the supply water

Select “**Conductivity**” in the water management settings submenu, then press the <Set> key.

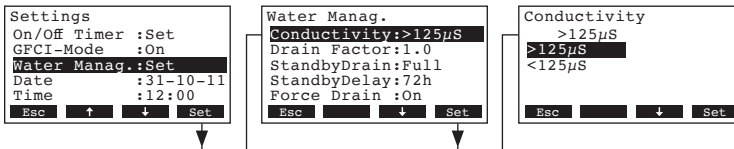

In the upcoming modification dialogue select the conductivity range of the supply water.

Factory setting: **>125 µS/cm**
 Options: **>125 µS/cm, <125 µS/cm**

4.6.7.2 Setting the drain factor

Select “**Drain Factor**” in the water management settings submenu, then press the <Set> key.

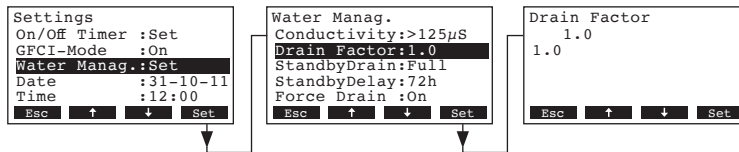

In the upcoming modification dialogue set the drain factor in relation to the steam capacity.

Factory setting: **1.0**
 Setting range: **0.5...2.0**

4.6.7.3 Selecting the type of draining in standby operation

Select “**StandbyDrain**” in the water management settings submenu, then press the <Set> key.

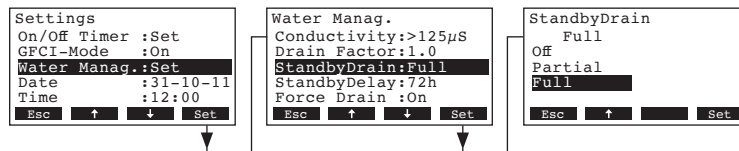

In the upcoming modification dialogue select the type of draining which takes place after a certain time (see following setting) in standby operation.

Factory setting: **Full**
 Options: **Full** (complete draining of the cylinder)
Partial (partial draining of the cylinder) **
Off (draining deactivated)

** The cylinder is drained so far that the water does not touch the electrodes any longer.

4.6.7.4 Setting the period of time in standby operation after which an automatic cylinder draining takes place

Select “**StandbyDelay**” in the water management settings submenu, then press the <Set> key.

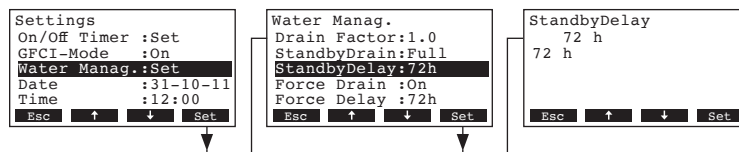

In the upcoming modification dialogue set the period of time in standby operation after which an automatic cylinder draining takes place.

Factory setting: **72 hours**
 Setting range: **1...720 hours**

4.6.7.5 Activating/Deactivating the forced draining

Select **"Force Drain"** in the water management settings submenu, then press the **<Set>** key.

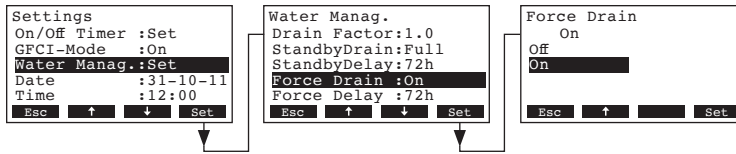

Activating/Deactivating the forced draining which takes place after a certain time of operation (see following setting).

Note: The forced draining takes place also during steam production.

Factory setting: **Off**
 Options: **On** (Forced draining activated)
Off (Forced draining deactivated)

4.6.7.6 Setting the time of operation after which a forced draining takes place

Select **"Force Delay"** in the water management settings submenu, then press the **<Set>** key.

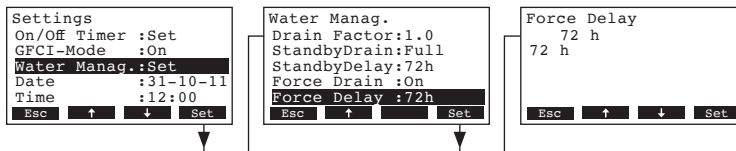

In the upcoming modification dialogue set the time of operation after which a forced draining takes place.

Factory setting: **72 hours**
 Setting range: **1...720 hours**

4.6.8 Setting the date

Select **"Date"** in the settings menu, then press the **<Set>** key.

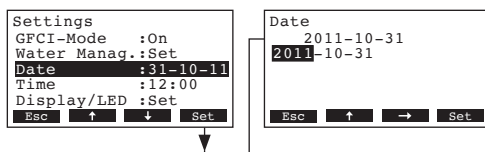

In the upcoming modification dialogue set the actual date (format:"yyyy-mm-dd").

4.6.9 Setting the time

Select “Time” in the settings menu, then press the <Set> key.

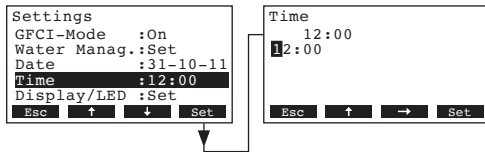

In the upcoming modification dialogue set the actual time (format:“hh:mm”).

4.6.10 Configuring the display and the steam LED

Select “Display/LED” in the settings menu, then press the <Set> key.

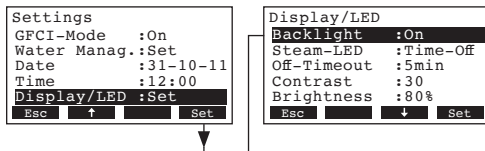

The display/LED settings appear. Press the <↓> and <↑> keys in order to select the individual settings. Detailed information on the different settings are found in the following chapters.

4.6.10.1 Configuring the backlight

Select “Backlight” in the display/LED settings submenu, then press the <Set> key.

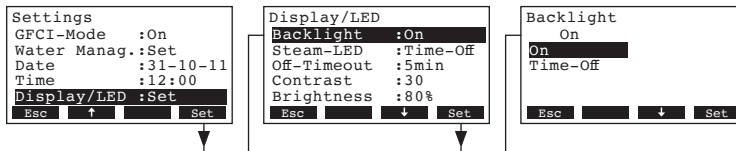

In the upcoming modification dialogue select whether the backlight should be permanently switched on (On) or the backlight is switched off after certain period of time (Time-Off).

Factory setting:

On

Options:

On (backlight permanently switched on)

Time-Off (backlight is switched off after a certain period of time, see chapter 4.6.10.3)

4.6.10.2 Setting the display behaviour of the LED steam

Select **"Steam-LED"** in the display/LED settings submenu, then press the **<Set>** key.

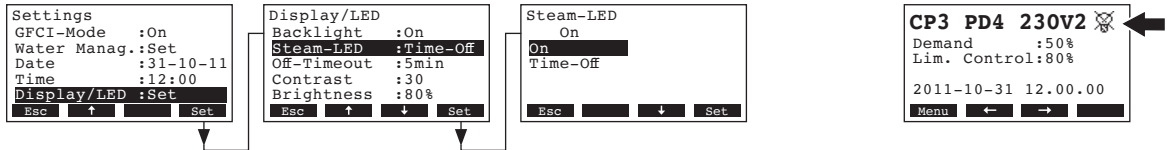

In the upcoming modification dialogue select whether the steam LED lights permanently (On) when steam is produced or the steam LED is switched off after certain period of time (Time-Off).

Factory setting: **On**

Options: **On** (Steam LED lights permanently when steam is produced)
Time-Off (Steam LED is switched off after certain period of time, see chapter 4.6.10.3)

Note: if "Time-Off" is selected, the crossed out LED symbol is shown in the upper right corner of the standard operating display afterwards (see the most right display above).

4.6.10.3 Setting the "Off-Timeout"

Note: this setting appears only if the settings "Backlight" and/or "Steam-LED" are set to "Time-Off".

Select **"Off-Timeout"** in the display/LED settings submenu, then press the **<Set>** key.

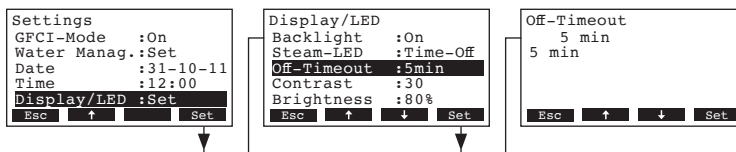

In the upcoming modification dialogue set the period of time after which the backlight and/or the steam LED should be switched off.

Factory setting: **5 minutes**

Setting range: **1...60 minutes**

4.6.10.4 Setting the contrast

Select **"Contrast"** in the display/LED settings submenu, then press the **<Set>** key.

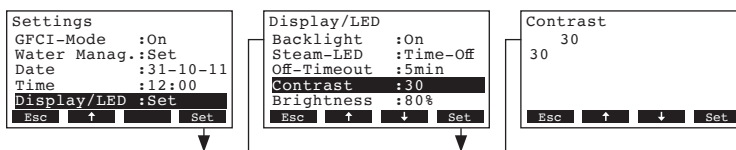

In the upcoming modification dialogue set the desired value for the display contrast.

Factory setting: **30**

Setting range: **10** (no display) ... **60** (display turns black)

4.6.10.5 Setting the brightness of the backlight

Select “**Brightness**” in the display/LED settings submenu, then press the **<Set>** key.

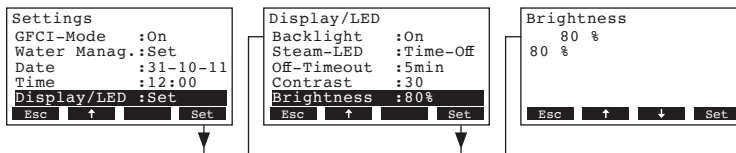

In the upcoming modification dialogue set the desired brightness value for the backlight in % of the maximum value.

Factory setting: **80 %**
 Setting range: **20...100 %**

4.7 Diagnostic functions

4.7.1 Interrogation of the malfunction list

The error messages generated by the last 20 malfunctions that occurred are saved in the malfunction list of the Condair CP3mini and can be interrogated.

Select the error history list:

Path: **Main menu > Diagnostic > ErrorHistory**

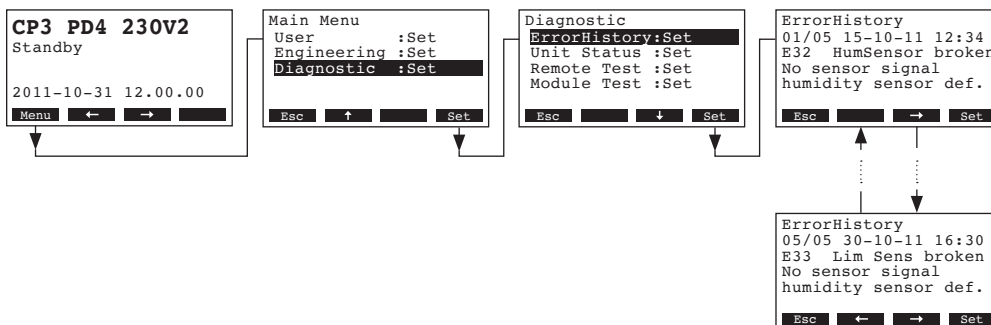

The last error that occurred is shown with:

- running number of the error
- date and time of occurrence
- error code (Warning: W..., Error: E...)
- error message
- additional info text regarding the error

Press **<←>** and **<→>** keys, in order to select further error messages in the list.

Press the **<Esc>** key several times to quit the error history list and to return to the standard operating display.

4.7.2 Interrogation of unit information

Select the list with the unit information:

Path: **Main menu > Diagnostic > Unit Status**

Press <↓> and <↑> keys, in order to select the unit information available in the list:

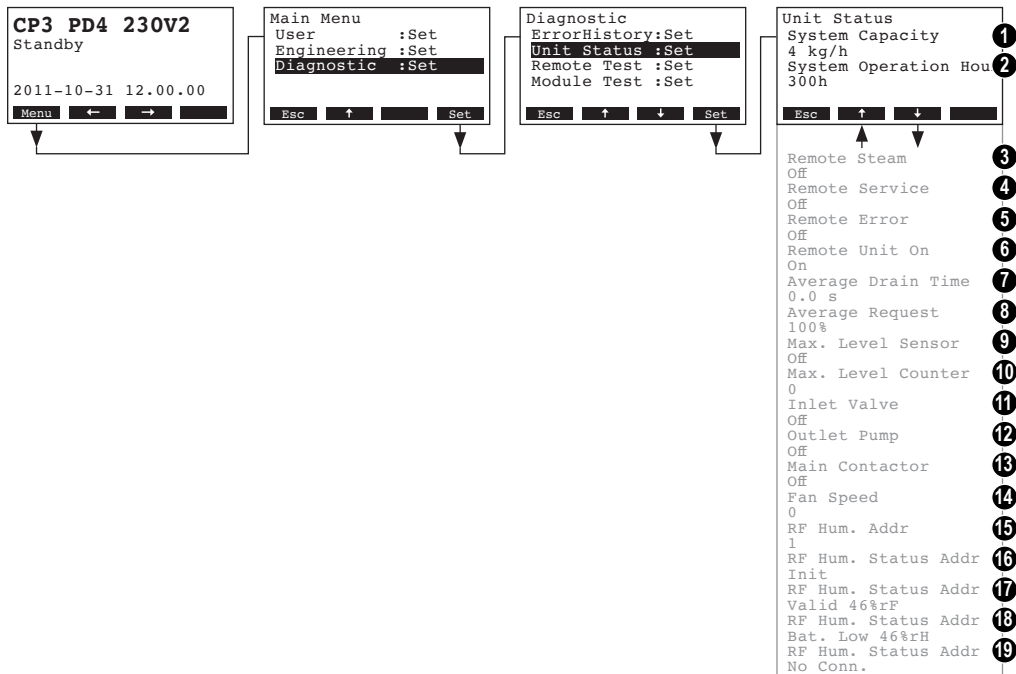

- 1 Steam capacity of the unit in kg/h
- 2 Total operating hours since the initial commissioning.
Note: The total operating hours are stored in the control board's internal memory every 24 hours (at 12:00 a.m.). If the device is switched off before the 24 hours have elapsed, the operating hours of the current day up to that point will not be updated.
- 3 Actual status of the remote indication relay "Steam"
- 4 Actual status of the remote indication relay "Service"
- 5 Actual status of the remote indication relay "Error"
- 6 Actual status of the remote indication relay "Unit on"
- 7 Calculated mean drain time in seconds
- 8 Current average request
- 9 Actual status of the maximum level sensor
- 10 Counter showing the number of times the maximum level in the steam cylinder has been exceeded
- 11 Actual status of the inlet valve
- 12 Actual status of the drain pump
- 13 Actual status of the heating voltage relay
- 14 Current number of revolutions of the fan (appears only with units type PR..)
- 15 Current set address of the radio humidity sensor
- 16 Actual signal on address 1 of the radio humidity sensor
- 17 Actual signal on address 2 of the radio humidity sensor
- 18 Actual signal on address 3 of the radio humidity sensor
- 19 Actual signal on address 4 of the radio humidity sensor

Press the <Esc> key several times to quit the unit information list and to return to the standard operating display.

4.7.3 Performing remote relay tests

Select remote relay tests:

Path: **Main menu > Diagnostic > Remote Test**

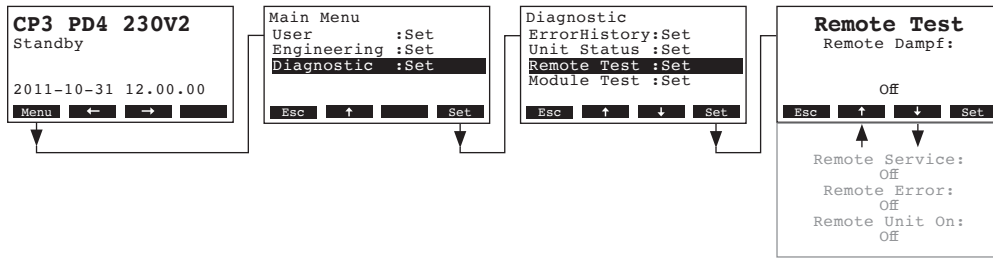

The list with the remote relay tests appears, the first relay test (steam) is shown.

Press the <↓> and <↑> keys in order to select the further relay tests available and press the <Set> key to activate/deactivate the corresponding relay for testing.

4.7.4 Performing Module tests

Select Module tests:

Path: **Main menu > Diagnostic > Module Test**

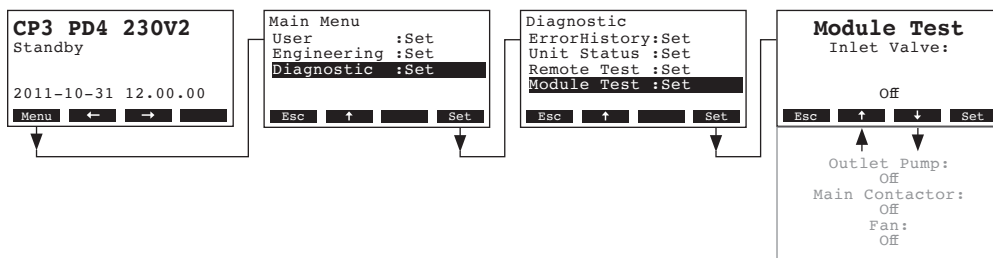

The list with the module tests appears, the first test (Inlet Valve) is shown.

Press the <↓> and <↑> keys in order to select the further tests of the selected module and press the <Set> key to activate/deactivate the corresponding component for testing.

5 Maintenance

5.1 Important notes on maintenance

Qualification of personnel

All maintenance work must be carried out only by **well trained personnel** who is familiar with the unit and the associated risks.

General notes

The instructions and details for maintenance work must be followed and upheld.

Only the maintenance work described in this documentation may be carried out.

Only use original Condair spare parts to replace faulty parts.

Safety

Some maintenance work requires removal of the unit cover. Please note the following:



DANGER!
Danger of electrical shock!

You may get in touch with live parts when the unit is open. Touching live parts may cause severe injury or even lethal violation.

Prevention: Before carrying out any maintenance work set the Condair CP3mini out of operation as described in chapter 4.3 (switch off the unit, disconnect it from the mains and stop the water supply) and secure the unit against inadvertent power-up.

CAUTION!

The electronic components inside the humidifier are very sensitive to electrostatic discharge.

Prevention: Before carrying out any maintenance work to the electrical or electronic equipment of the humidifier, appropriate measures must be taken to protect the respective components against damage caused by electrostatic discharge (ESD protection).

5.2 Maintenance list

To maintain operational safety the Condair CP3mini steam humidifier must be maintained at regular intervals. This is differentiated between the **first maintenance after approx. 500 operating hours (I)**, the **replacement of the steam cylinder after the yellow LED lights (II)** and **annual maintenance (III)**.

Below you will find a summary of the work to be carried out for each of the three maintenance stages.

Components	Interval			Work to be done
	I	II	III	
Steam cylinder		X		Remove and replace.
Drain pump			X	Remove, disassemble and clean, replace if necessary.
Steam cylinder receptacle			X	Inspect, clean if necessary.
Inlet valve			X	Remove and clean filter insert, replace if necessary.
Drain pipe and siphon			X	Inspect, clean if necessary (decalcify and rinse out).
Steam installation	X		X	Inspect steam and condensate hoses for cracks and to see that they are correctly attached, replace faulty hoses.
Water installation	X		X	Inspect water hoses in the unit for cracks and to see that they are correctly attached, replace faulty hoses Check supply pipe is tight, make tight if necessary. Clean water filter, if available.
Electrical installation	X		X	Check all cables in the unit are firmly positioned and examine status of insulation.

5.3 Removing and installing parts for maintenance

5.3.1 Removal and installation of the steam cylinder

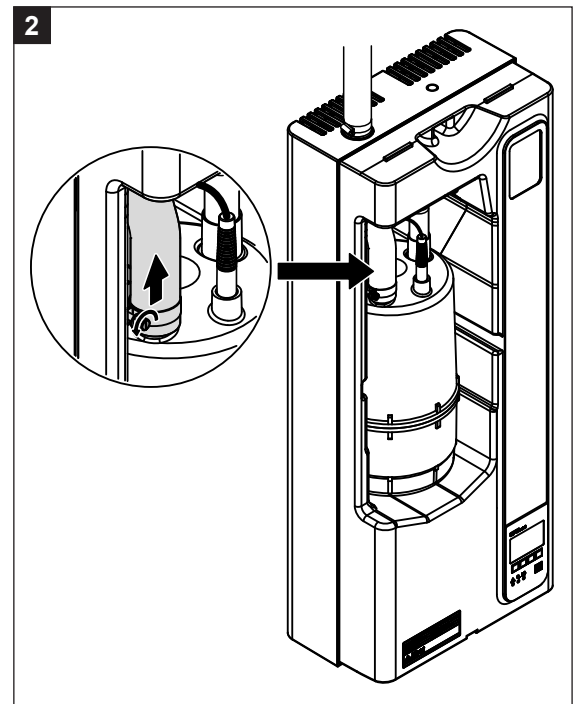
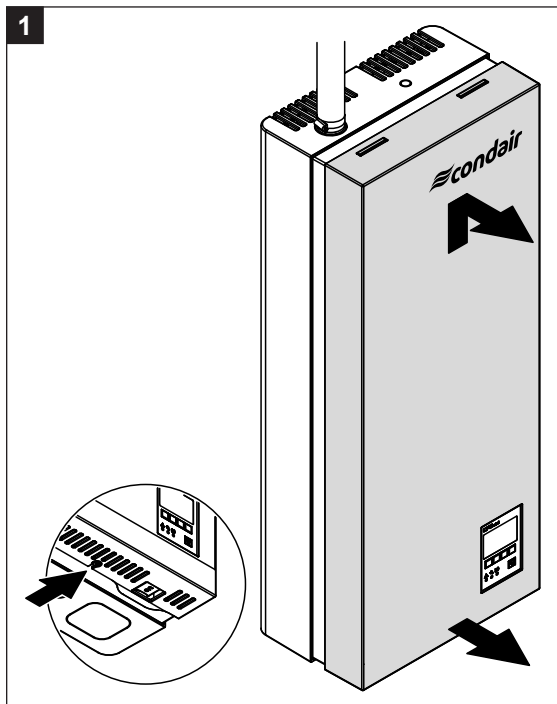

1. Loosen the fixing screw of the front cover on the bottom side of the intermediate panel a few turns. Pull the lower part of the front cover to the front, then push the cover upward and remove it.
2. Release the hose clamp on the steam connector of the steam cylinder, then detach the steam hose from the steam connector.

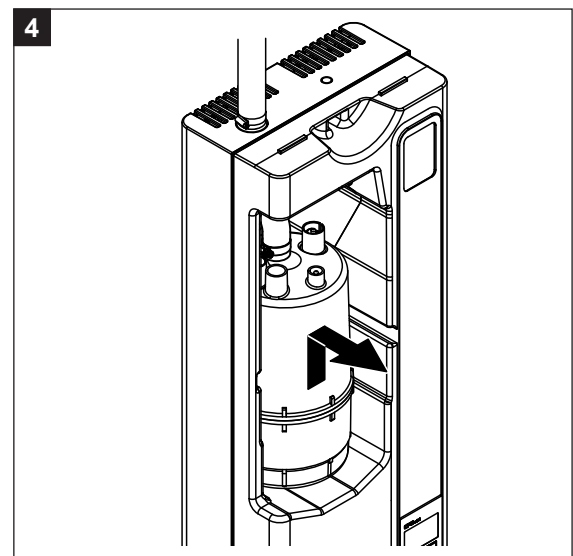
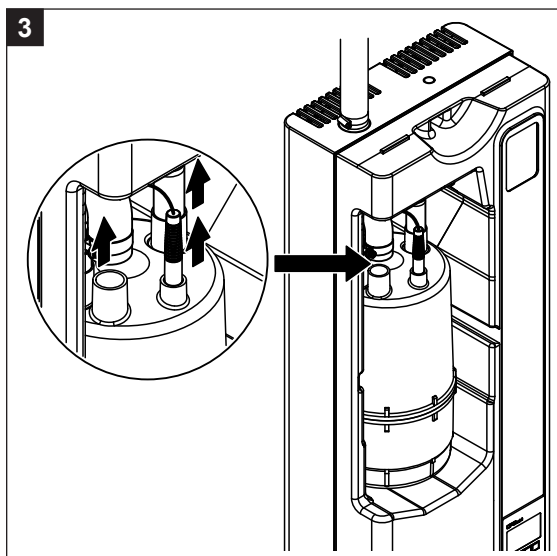

3. Remove the plugs from the electrodes and from the level sensor.
4. Carefully lift steam cylinder out of the cylinder receptacle, then remove it to the front.

CAUTION!

Put steam cylinder down carefully to avoid damage to the lower connection piece!

Installation of the steam cylinder follows the reverse sequence. **Observe the following:**

- Before installing the steam cylinder in the unit, check the O-ring of the cylinder receptacle for damage and replace if necessary.
- Moisten the O-ring of the cylinder receptacle with water (do not use grease or oil), then insert steam cylinder into the receptacle and push it down to the stop.
- Attach the electrode plugs and the level sensor plug to the respective electrode and sensor connections according to the colour dots on the steam cylinder (see also following illustration).

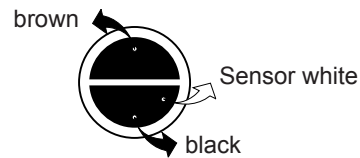

- Fasten steam hose on the steam connector of the cylinder with hose clamps.

CAUTION!

A leaky steam hose can cause damage due to moisture inside the unit.

CAUTION!

The outlet connector of the steam cylinder is made of plastic. **Do not overtighten** the hose clamp on the steam connector of the steam cylinder.

5.3.2 Disassembly and assembly of the components of the water system

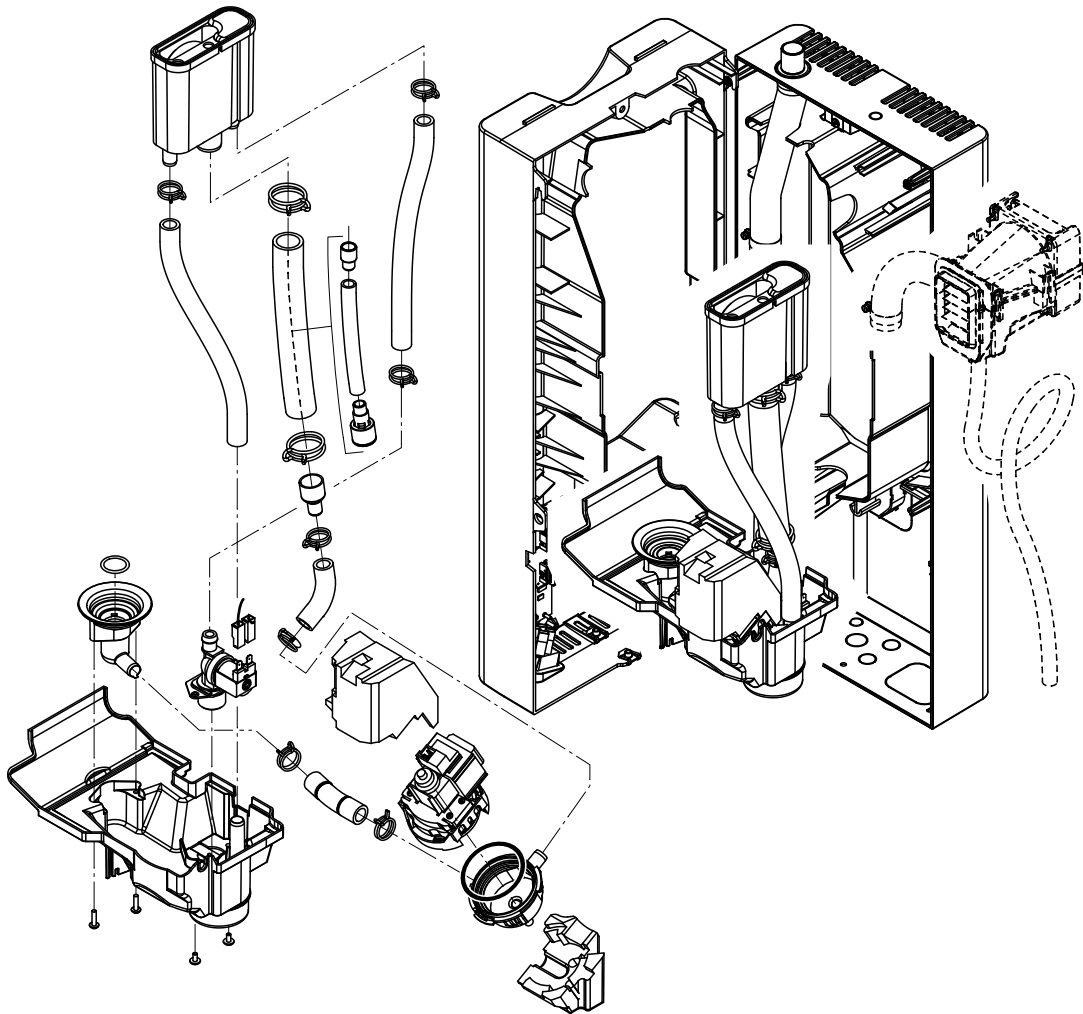

To dismantle the components of the water system proceed as follows:

1. Dismount the steam cylinder (see chapter 5.3.1).
2. Undo the two screws of the intermediate panel. Then, carefully remove the intermediate panel to the front, swivel it to the left and hang it onto the pins of the back panel.
3. Undo water supply and water drain pipe.
4. Unit type PR.. only: Disconnect the electric cables, then remove the ventilation unit together with the steam and condensate hose to the front.
5. Undo the attachment of the flat ribbon cable on the tub (rubber band), then pull cable out of the bracket.
6. Remove connecting cables from drain pump and inlet valve.
7. Release the fixing clip of the water cup, then carefully pull out the water cup together with the hoses and tub to the front. While pulling out the parts disconnect the electric cables from the drain pump and the inlet valve as well as the ground cable from the corresponding connector in the water drain.
8. Now, the individual components of the water system can be separated for inspection and cleaning.

The **installation** of the components of the water system follows the reverse sequence. Before fixing the water hoses to the connector using the hose clamps, align the hoses in a way that they are not twisted. Make sure all electric cables are reconnected correctly.

5.4 Notes on cleaning the unit components

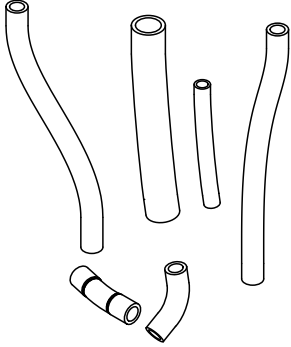
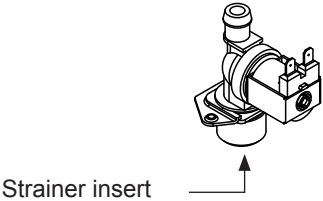
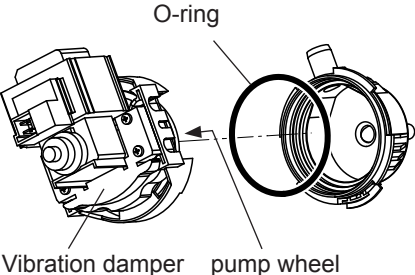
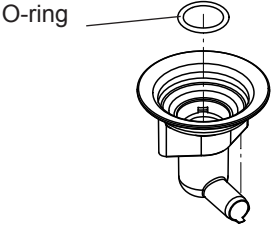
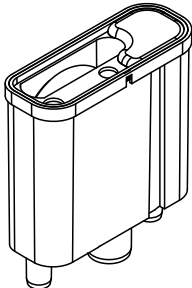
Unit component	What to clean and how to clean
<p>Water hoses</p> 	<ul style="list-style-type: none"> Remove any limescale by slightly knocking on the tubes using a rubber hammer. Then, rinse the tubes well with hot tap water.
<p>Inlet valve</p>  <p>Strainer insert</p>	<ul style="list-style-type: none"> Remove strainer insert with pointed pliers. Use a brush (do not use a wire brush) to remove any limescale. Wash strainer insert with a lukewarm soap solution, then rinse well with tap water. <p>Let the inlet valve dry before reinstallation!</p>
<p>Drain pump</p>  <p>O-ring Vibration damper pump wheel</p>	<ul style="list-style-type: none"> Use a brush to remove any limescale from the pump housing and the pump wheel (do not use a wire brush). Then, wipe pump wheel with a damp cloth. Wash the pump housing with a lukewarm soap solution and rinse well with tap water. <p>Note: If the pump needs to be replaced remove the vibration damper (noise reduction) from the defective pump and refit it on the new pump.</p>
<p>Cylinder receptacle in the unit</p>  <p>O-ring</p>	<ul style="list-style-type: none"> Remove any limescale from the cylinder receptacle and its connectors using a brush (do not use a wire brush). If the cylinder receptacle is heavily calcified, place it in an 8% formic acid solution (observe safety notes in chapter 5.5), until the limescale comes off. Wash the cylinder receptacle with a lukewarm soap solution and rinse well with tap water. Check O-ring and replace if necessary.
<p>Water cup</p> 	<ul style="list-style-type: none"> Remove any limescale from the water cup and its connectors using a brush (do not use a wire brush). If the water cup is heavily calcified, place it in an 8% formic acid solution (observe safety notes in chapter 5.5), until the limescale comes off. Wash the water cup with a lukewarm soap solution and rinse well with tap water.

Unit component	What to clean and how to clean
Interior of the unit (water side only)	Wipe the interior of the unit with a damp cloth without using any cleaning agent. Take care that the electrical connections and the electronic components remain dry.

5.5 Notes on cleaning agents

Only use cleaning agents stated in the table above. The use of disinfectants is only permitted if they do not leave any toxic residues. In any case the parts must be thoroughly rinsed with water after cleaning.



WARNING!

Formic acid is indeed harmless to the skin, but it attacks the mucous membranes. Therefore prevent your eyes and respiratory tracts from getting in touch with the acid and its vapours (wear goggles and work in a well ventilated room or outside).

CAUTION!

Do not use any solvents, aromatized or halogenized hydrocarbons or other aggressive substances as they may cause damage to the components of the unit.

It is mandatory to observe and comply with the information and instructions regarding cleaning agents. Observe in particular: all information relating to the protection of personnel, environmental protection and restrictions regarding usage.

5.6 Resetting the maintenance indication

After completing maintenance work, the **maintenance indication** (yellow LED lights) must be reset as follows:

Select the maintenance menu:

Path: **Main menu > User > Password entry: 8808 > Maintenance**

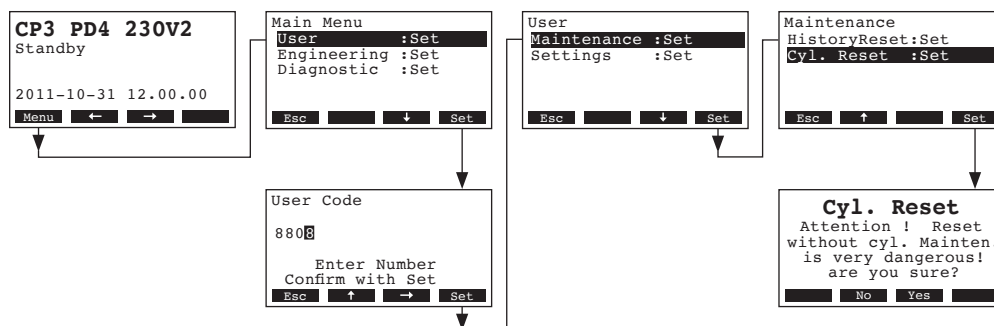

Select **"Cyl. Reset"**, then press the **<Set>** key.

The reset dialogue shows up in the display. Press the **<Yes>** key to reset the maintenance counter.

Note: Press the **<No>** key if you wish to abort the reset procedure.

To return to the standard operating display press the **<Esc>** key several times.

6 Fault elimination

6.1 Fault indication

Malfunions during operation are indicated by a corresponding **Warning** or **Fault** message in the display of the control unit (each warning and fault message is stored in the error list):

– Warning messages

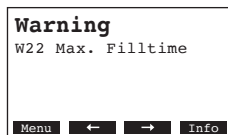

Further operation is still possible. The control of the CP3mini checks whether there is a temporary problem (e.g. water supply interrupted for a short time) or whether it can resolve the problem by taking necessary measures. If the cause of the malfunction disappears of its own accord or if the control can repair the malfunction, the alarm message will automatically switch off. If the cause of the malfunction does not disappear even after a longer period of time, a fault message is triggered.

– Fault message (additionally to the fault message the **red LED lights**)

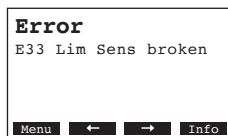

Further operation is normally not possible any longer, the unit is blocked. To eliminate the malfunction see chapter 6.2 and 6.3.

Note: After eliminating the malfunction the fault message must be reset (see chapter 6.4).

By pressing the **<Info>** key additional information can be displayed for each warning and/or fault message.

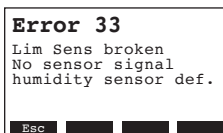

6.2 Malfunction list

Important! Most operational malfunctions are not caused by faulty equipment but rather by improper installation or disregarding of planning guidelines. Therefore, a complete fault diagnosis always involves a thorough examination of the entire system. Often, the steam hose connection has not been properly executed, or the fault lies with the humidity control system.

6.2.1 System faults

Warning		Error		Cause	Remedy
LED	Display	LED	Display		
CF card missing (Test run possible)		CF card missing			
—	Warning W1: CF card Missing	red lights	Error E1: CF card Missing	No CF card installed on the control board.	Install CF card or start test run.
		CF card is empty			
—	—	red lights	Error E2: CF card Empty	No data stored on the CF card.	Install new CF card.
		CF card is defective			
—	—	red lights	Error E3: CF card Invalid	Invalid data stored on the CF card.	Install new CF card.
		CF card is incompatible			
—	—	red lights	Error E4: CF card incompat	The installed CF card is not compatible with the hardware of the unit or with the basic settings of the control electronics.	Install correct CF card. Let your Condair service technician adjust the basic settings.
		Wrong hardware settings			
—	—	red lights	Error E9: Illegal Settings	False test run parameters.	Let your Condair service technician adjust the test run parameters (heating voltage, Cylinder-No.).
		Hardware fault			
—	—	red lights	Error E10: Flash R/W Fault	Control board defective.	Replace control board.
—	—		Error E11: Clock R/W Fault	Backup battery on control board discharged.	Let have the backup battery be replaced (see chapter 6.5).
On/Off timer active					
—	Warning W12: Timer Disable	—	—	The system is deactivated via the On/Off-Timer.	None. If necessary adjust On/Off timer settings.

6.2.2 Unit faults

Warning		Error		Cause	Remedy
LED	Display	LED	Display		
External safety chain is open					
red and green flash	Warning W20: Safety loop open	—	—	Ventilation interlock open.	If applicable, check/turn on ventilation system.
				Air flow monitor triggered.	Check ventilator/filter of the ventilation system.
				Safety humidistat triggered.	Wait. If applicable, check safety humidistat
Max. filling level of steam cylinder reached					
—	Warning W21: Cyl.Max.Level	red lights	Error E21: Cyl.Max.&NoCurr	Water conductivity too low (after initial operation).	Wait until the mineral content of the cylinder has increased
				Phase failure heating voltage.	Check service switch in the mains supply line and switch on if applicable. Check mains fuse(s) and replace if applicable.
Permissible filling time exceeded (20 minutes)					
—	Warning W22: Max. Filltime	red lights	Error E22: Max. Filltime	Water supply obstructed/shut-off valve closed/water pressure too low.	Inspect water supply (filter, water piping, etc.), check/open shut-off valve, check water pressure.
				Inlet valve blocked or defective.	Inspect strainer insert in the inlet valve, if applicable clean strainer insert or replace inlet valve.
				Excessive back pressure in the steam line (duct pressure too high, steam line too long or kinked), causing water loss via filling cup.	Check duct pressure, inspect steam installation. If applicable install pressure compensation kit (see options).
				Leakage in the water system.	Inspect water system and seal if necessary.
No electrode current for more than 20 minutes					
—	Warning W23: No Current	red lights	Error E23: No Current	Phase failure heating voltage.	Inspect/turn on service switch of the mains supply line. Inspect the fuses of the mains supply, replace if necessary.
				Water supply obstructed/shut-off valve closed/water pressure too low.	Inspect water supply (filter, water piping, etc.), check/open shut-off valve, check water pressure.
				Inlet valve blocked or defective.	Inspect strainer insert of the inlet valve, if applicable clean strainer insert or replace inlet valve.
				Excessive back pressure in the steam line (duct pressure too high, steam line too long or kinked), causing water loss via filling cup.	Check duct pressure, inspect steam installation. If applicable install pressure compensation kit (see options).
				Leakage in the water system.	Inspect water system and seal if necessary.
Electrode current in relation to the steam demand too high					
—	Warning W24: Over Current	red lights	Error E24: Over Current	Humidity demand has decreased too fast.	Automatic adaptation of the operating point.
				Drain pump defective.	Inspect drain pump, replace if necessary.
				Drain in steam cylinder blocked.	Replace steam cylinder.
Max. admissible electrode current exceeded					
—	Warning W25: Excess Current	red lights	Error E25: Excess Current	Drain pump defective.	Inspect drain pump, replace if necessary.
				Drain in steam cylinder blocked.	Replace the steam cylinder.

Warning		Error		Cause	Remedy
LED	Display	LED	Display		
		Relay heating voltage jammed			
—	—	red lights	Error E26: Req.Off Current	Relay heating voltage jammed in activated position.	Inspect relay, replace if necessary.
Foam detection		Foam detection (4 automatic drainings within 24 hours)			
—	Warning W27: Foam	red lights	Error E27: Foam	Foaming in steam cylinder.	Drain steam cylinder via drain key (several times, if necessary). Check quality of the supply water.
Steam cylinder needs service		Service interval for steam cylinder exceeded			
yellow lights	Warning W28: Cyl. Maintenance	red and yellow flash	Error E28: Cyl. Maintenance	Mineral deposits and/or electrodes spent.	Replace steam cylinder. Important: After replacement of the steam cylinder, reset the maintenance counter (see chapter 5.6).
Steam cylinder needs service		Max. operating hours of the steam cylinder reached			
yellow lights	Warning W29: Cyl. Maintenance	red and yellow flash	Error E29: Cyl. Maintenance	Maximum operating hours of the steam cylinder reached.	Replace steam cylinder. Important: After replacement of the steam cylinder, reset the maintenance counter (see chapter 5.6).
Humidity sensor signal (signal Y) missing		Humidity sensor signal (signal Y) missing for more than 1 minute			
—	Warning W32: Ctrl.Sens.Broken	red lights	Error E32: Ctrl.Sens.Broken	No sensor signal present at signal input (Signal Y).	Check humidity sensor (signal Y) , replace if necessary. Inspect wiring.
Signal of humidity limitation sensor (signal Z) missing		Signal of humidity limitation sensor (signal Z) missing for more than 1 minute			
—	Warning W33: Lim.-Sens.def.	red lights	Error E33: Lim.Sens.Broken	No sensor signal present at signal input (signal Z).	Check humidity sensor (signal Z) , replace if necessary. Inspect wiring.
Standby draining of steam cylinder active					
—	Warning W36: Standby Drain	—	—	Automatic standby draining of steam cylinder active.	No measures must be taken.
Forced draining of steam cylinder active					
—	Warning E37: Forced Drain	—	—	Forced draining of steam cylinder active.	No measures must be taken.
Safety chain instable					
—	Warning W38: Safety Loop Inst	—	—	Safety chain opens and closes in short intervals.	Check/replace safety humidistat, ventilation interlock and air flow monitor.
Control signal instable					
—	Warning W39: Control Instable	—	—	The signal at the control signal input fluctuates strongly in short intervals.	Check/replace humidity sensor or external humidity controller.
Limit humidity signal instable					
—	Warning W40: Limit Instable	—	—	The signal at the limit signal input fluctuates strongly in short intervals.	Check/replace humidity sensor or external humidity controller.

Warning		Error		Cause	Remedy
LED	Display	LED	Display		
No reception from radio humidity sensor		No reception from radio humidity sensor for more than 15 minutes			
—	Warning W43: RF Hum. No Conn.	—	Error E43: RF Hum. No Conn.	The control does not receive any signal from the radio humidity sensor.	Check/replace radio humidity sensor and/or receiver on the control board. If necessary change radio address.
Battery in the radio humidity sensor spent		Battery in the radio humidity sensor spent			
—	Warning W44: RF Hum. Battery	—	Error E44: RF Hum. Battery	Battery in the radio humidity sensor spent	Replace Battery of the radio humidity sensor.

6.3 Notes on fault elimination



For the elimination of faults **set the steam humidifier out of operation** as described in chapter 4.3, **separate the unit from the mains** and **secure it against inadvertent power-up**.

The elimination of faults must be carried out by qualified and well trained professionals only. Malfunctions relating to the electrical installation (e.g. replacement of the backup battery, replacement of fuses) must be repaired by authorized personnel or by your Condair representative's service technician only.

Repair work and the replacement of faulty components must be carried out by your Condair representative's service technician only!

6.4 Resetting the error indication (red LED lights)

To reset the error indication:

Disconnect the steam air humidifier from the mains. Wait approx. 5 seconds, then reconnect the unit to the mains.

Note: If the fault has not been eliminated, the error indication reappears after a short while.

6.5 Replacing the backup battery on the control board

1. Set the Condair CP3mini out of operation as described in chapter 4.3, disconnect it from the mains and secure the unit against inadvertent power-up.
2. Loosen the fixing screw of the front cover on the bottom side of the intermediate panel a few turns. Pull the lower part of the front cover to the front, then push the cover upward and remove it.
3. Undo the two screws of the intermediate panel. Then, carefully remove the intermediate panel to the front, swivel it to the left and hang it onto the pins of the back panel.

CAUTION!

The **electronic components** inside the humidifier are **very sensitive to electrostatic discharge**. Before carrying out the next step, appropriate **measures must be taken to protect the electronic components against damage caused by electrostatic discharge (ESD protection)**.

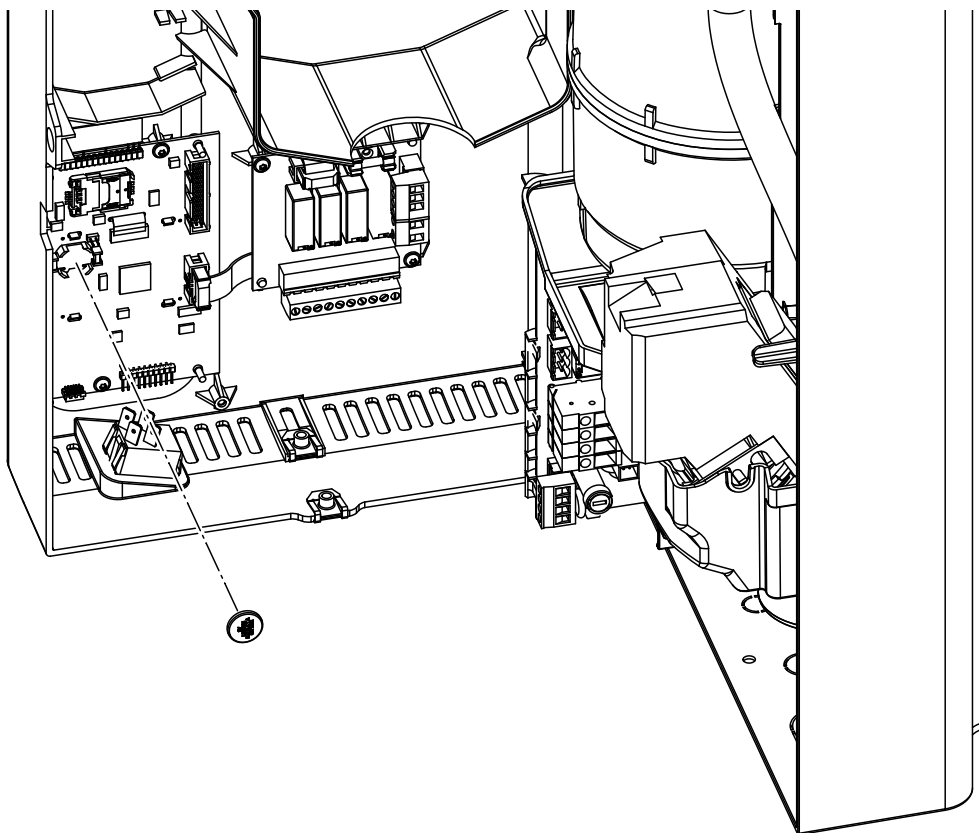

4. Replace the backup battery (CR1632, Lithium 3V).
5. Reassemble the unit in reverse order.
6. If necessary set date and time (see chapter 4.6.8 and 4.6.9).



WARNING!
Environmental hazard!



The old battery must be returned to an authorised collecting point for correct disposal/recycling in accordance with local regulations. In no case the old battery must be disposed of in the domestic waste or into the environment.

7 Taking out of service/Disposal

7.1 Taking out of service

If the Condair CP3mini must be replaced or if the humidification system is not needed any more, proceed as follows:

1. Take the unit out of operation as described in chapter 4.3.
2. Have the unit (and all other system components, if necessary) unmounted by a qualified service technician.

7.2 Disposal/Recycling



Components not used any more must not be disposed of in the domestic waste. Please dispose of the unit or the individual components in accordance with local regulations at the authorised collecting point.

If you have any questions, please contact the responsible authority or your local Condair representative.

Thank you for your contribution to environmental protection.

8 Product specifications

8.1 Technical data

	Condair CP3mini			
	PD2	PD4	PR2	PR4
Heating voltages	230V1~ / 50..60Hz 240V1~ / 50..60Hz 200V2~ / 50..60Hz			
Steam capacity	2 kg/h	4 kg/h	2 kg/h	4 kg/h
Max. power consumption	1.6 kW	3.1 kW	1.6 kW	3.1 kW
Control voltages	230V1~ / 50..60Hz 240V1~ / 50..60Hz 200V2~ / 50..60Hz			
Operating data				
Air volume fan	—		22 m ³ /h	
Sound pressure level	—		37 dB(A) **	
Max. room size (guideline)	—		200 m ³	400 m ³
Admissible control signals	On/Off (24VDC), 0..5VDC Potentiometer, 1..5VDC, 0..10VDC, 2..10VDC, 0..16VDC, 3.2..16VDC, 0..20mA, 4..20mA			
Admissible water pressure	1...10 bar (100...1000 kPa)			
Water quality	Untreated drinking water with a conductivity of 125...1250 µS/cm			
Admissible water temperature	1...40 °C			
Admissible ambient temperature	1...40 °C			
Admissible ambient humidity	max. 75 %rh			
Admissible duct air pressure	-0.8 kPa...0.8 kPa		—	
Type of protection	IP20			
Conformity	CE, VDE			
Dimensions/Weights				
Housing (B x H x T)	265 mm x 650 mm x 175 mm			
Net weight	6.2 kg			
Operating weight	11.0 kg			
Equipment				
Steam cylinder type	A2..			
Options				
Cable glands set	1x CG			
Radio humidity sensor (transmitter and receiver)	1x RH			
Water drain hose	1x WDH			
Remote operating and fault indication	1x RFI			
Accessories				
Filter valve	1x Z261			
Steam nozzle	1x W21	—		
Steam distribution pipe	1x 41-...	—		
Steam hose / meter	DS22	—		
Condensate hose / meter	KS10	—		
Humidity sensor for duct installation	1(2)x CDC	—		
Humidity sensor for room installation	—	1(2)x CRC		
Duct humidistat	1x CHD	—		
Room humidistat	—	1x CHR		

** During de-scaling higher sound pressure level values (up to 45 dBA) may be achieved for a short period of time

8.2 Wiring diagram Condair CP3mini

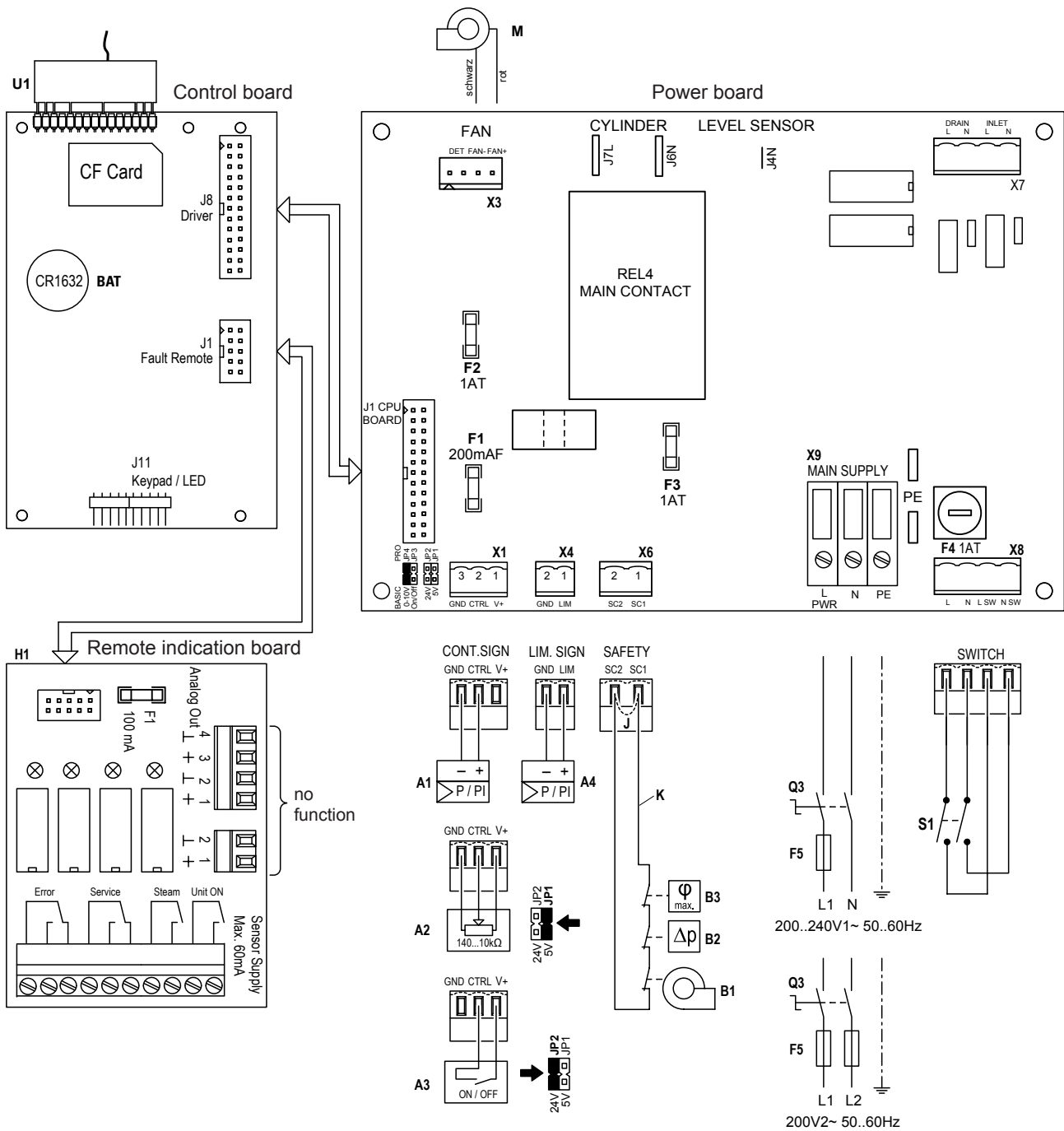

- A1 Controller (active) or humidity sensor
- A2 Controller (passive),
set jumper on JP1 (5V) and remove jumper from JP2 (24V)
- A3 On/Off controller,
set jumper on JP2 (24V) and remove jumper from JP1 (5V)
- A4 Limitation signal
- BAT Backup battery (CR1632, Lithium 3V)
- B1 Ventilation interlock
- B2 Safety humidistat
- B3 Airflow monitor
- F1 Internal fuse "Power board": control signal (200 mA, fast acting)
- F2 Internal fuse "Power board": control 5 V (1 A, slow acting)
- F3 Internal fuse "Power board": control 24 V (1 A, slow acting)
- F4 Internal fuse "Power board": control voltage (1 A, slow acting)
- F5 External fuse supply voltage (see table in chapter 5.5.2 of the mounting instructions)
- H1 Remote operating and fault indication
- J Short circuited, if no external monitoring devices are connected

- JP1 Outlet voltage at X1, V+ = 5 V
- JP2 Outlet voltage at X1, V+ = 24 V
- JP3 Do not set a jumper
- JP4 Jumper must be set
- K External safety chain (24 VDC)
- M Ventilation unit (unit type PR... only)
- Q3 External Service switch voltage supply
- S1 Unit switch
- REL4 Relay Heating voltage
- U1 Receiver radio humidity sensor
- X1 Connector control signal
- X3 Connector ventilation unit (unit type PR... only)
- X4 Connector limit signal
- X6 Connector external safety chain
- X8 Connector Unit switch
- X9 Connection terminal voltage supply

Notes

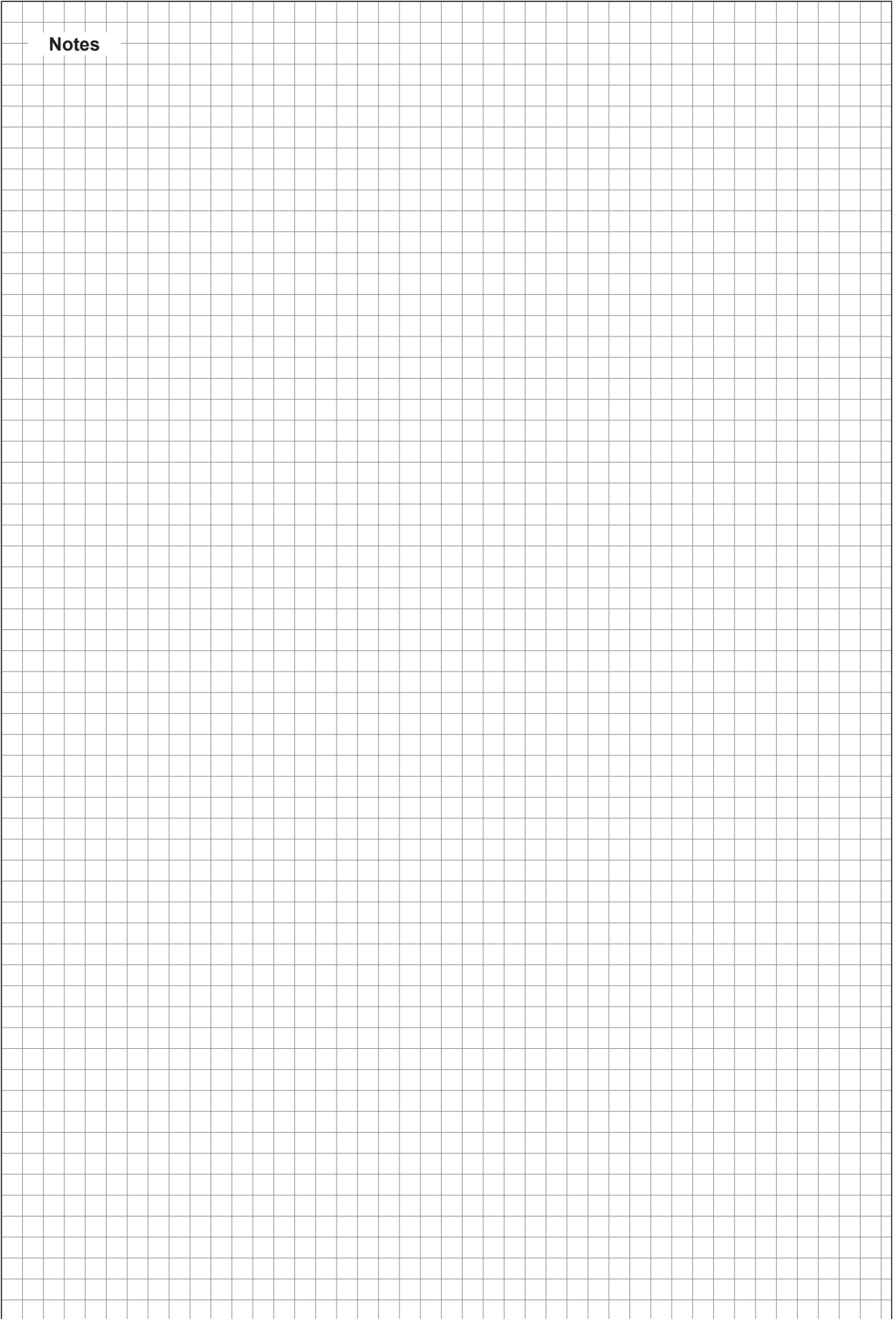

Notes

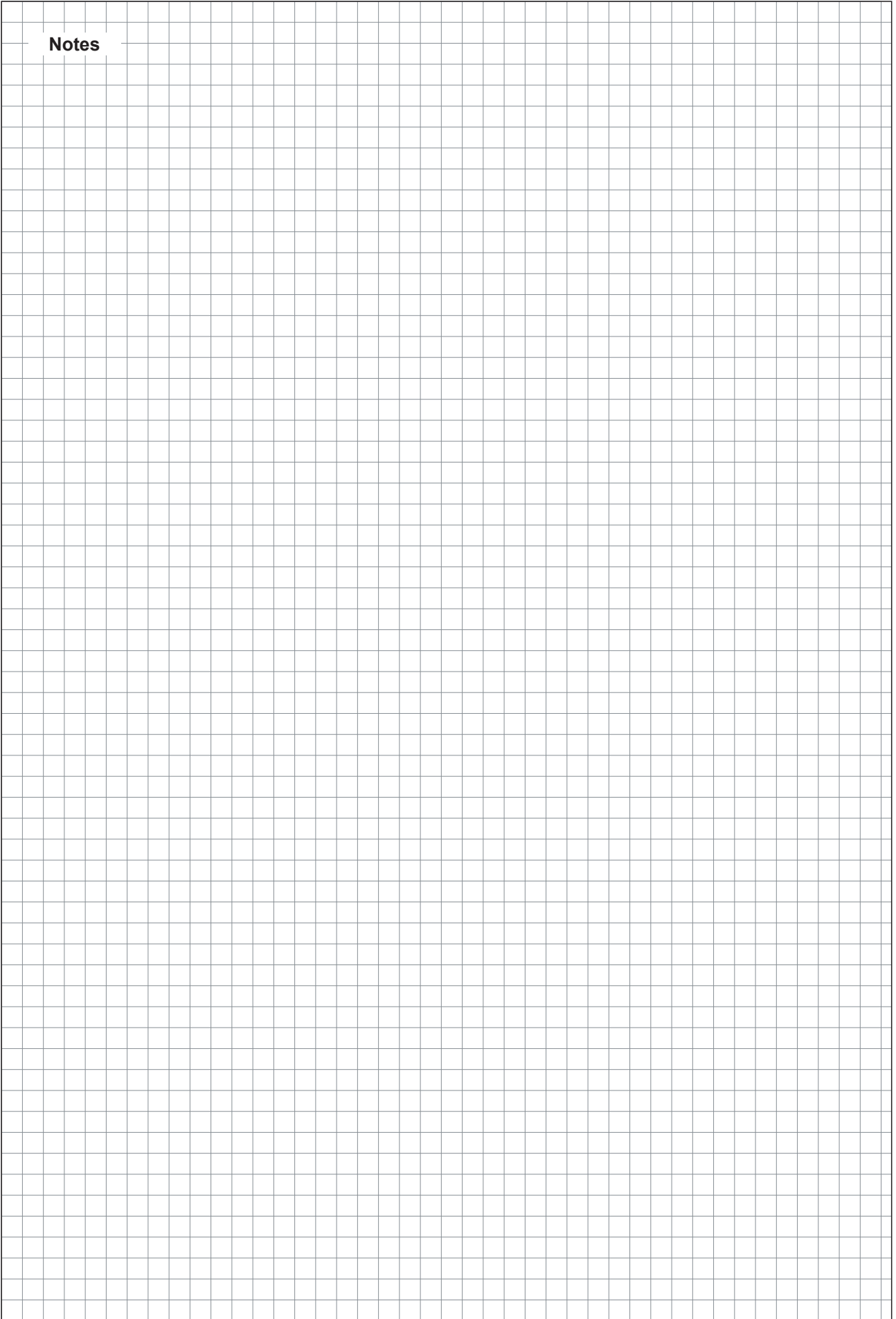

Notes

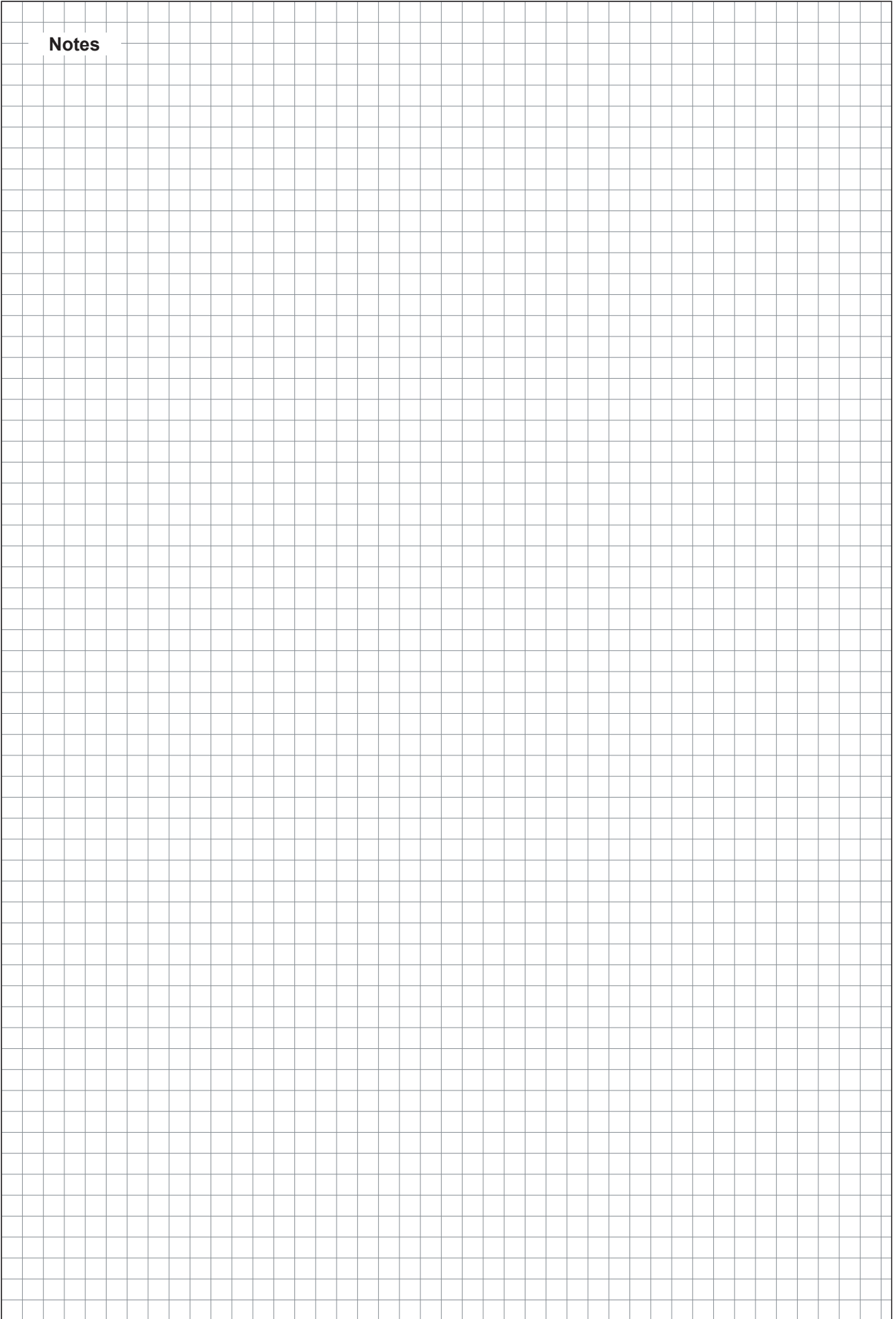

CONSULTING, SALES AND SERVICE:



CH94/0002.00

Condair Group AG
Gwattstrasse 17, 8808 Pfäffikon SZ, Switzerland
Phone +41 55 416 61 11, Fax +41 55 588 00 07
info@condair.com, www.condairgroup.com

The Condair logo, consisting of a stylized wave symbol to the left of the word 'condair' in a bold, lowercase, sans-serif font.