

Installation and Operating Instructions

AIRWIN®
Ultrasonic Universal Humidifier

UB-1...4/CT/3.1



Type	Item no.	Description	Max. output
UB-1/CT/3.1	7900264	Universal humidifier with CT-1 control and 1 active aerosol outlet	0.5 kg/h
UB-2/CT/3.1	7900265	Universal humidifier with CT-1 control and 2 active aerosol outlets	1.0 kg/h
UB-3/CT/3.1	7900266	Universal humidifier with CT-1 control and 3 active aerosol outlets	1.5 kg/h
UB-4/CT/3.1	7900267	Universal humidifier with CT-1 control and 4 active aerosol outlets	2.0 kg/h



Please read and keep these instructions!

valid from serial number: 4720

Contents

1.	General Informations and intended use	4
2.	Safety Instructions	4
3.	Scope of delivery	5
4.	Optional accessories	6
5.	General information	8
5.1	Technical terms	8
5.2	Physical principles of piezo ceramics.....	8
5.3	Functional description - ultrasonic air humidifier	9
6.	Advantages of ultrasonic air humidification	10
7.	Device overview.....	11
7.1	The UB-1...4/CT/3.1-System	12
8.	Installation conditions	13
9.	Aerosol distribution systems	14
9.1	Aerosol Jet	14
9.2	Aerosol pipes.....	15
9.3	Joined aerosol outlets	15
10.	Hydraulic connection	16
10.1	Hydraulic conditions	16
10.1	Establishing and detaching the connections with connectors.....	17
11.	Electric connection.....	18
11.1	Control connection	18
11.1.1	Safety chain	20
11.1.2	Status Message Operation - Error	20
11.2	Device control.....	21
11.2.1	Continuous control - analogous input	21
11.2.2	Fault signal - value below set humidity value	21
11.2.3	Control via Modbus RTU.....	21
12.	Operation	22
12.1	Setting of set point.....	22
12.2	Level concept	22
12.3	Parameter level	23
12.4	Autotuning (self-optimisation).....	24
13.	Structure and functions of the control board AIRWIN 3.1	25
13.1	Connections	25
13.2	Functional description of the controller	27
13.3	Standard Settings.....	28
13.4	Settings	29
13.5	State diagram	31
13.6	Status messages.....	32
13.7	LED-Indicator and decoding.....	32



13.8	Resetting the maintenance interval	33
13.9	Troubleshooting	34
14.	AquaDrain plus - hygiene management	35
14.1	Description	35
14.2	Features	36
14.2.1	Flushing of water supply line	36
14.2.2	Drainage of fluid tank.....	38
14.3	AquaDrain diagrams	39
15.	Commissioning	40
15.1	Manual functions	40
15.2	Automatic functions.....	41
15.3	Make applied settings	41
16.	Operation.....	42
17.	Technical data	43
18.	Equipment dimensions / weights	44
19.	Circuit diagrams.....	45
20.	Care	47
21.	Standards	49
21.1	EC declaration of conformity according to Machinery directive 2006/42/EC, Annex II 1.A	49
21.2	WEEE.....	49
21.3	Legal notice - Copyright	49
22.	List of figures	50
23.	List of tables	51

1. General Informations and intended use

The device is designed for the humidification of demineralised water according to the technical specifications.

Nebulization of other liquids is not permitted.

These installation and operation instructions apply to all AIRWIN® ultrasonic universal humidifiers of UB-1...4/CT/3.1 series, hereafter referred to as humidifier. It contains important notes for professional installation, start-up, trouble-free operation, proper maintenance and cleaning.

In addition to regular maintenance, proper installation and care of the humidifier help to preserve the value of the humidifier and are conditions for warranty claims.







2. Safety Instructions

The humidifier described in these instructions was developed and manufactured in accordance with international safety regulations. However, the device must be handled with care, in particular to ensure electric safety.





In order to guarantee safe operation in all operating conditions, the following safety instructions must be observed.

	<ul style="list-style-type: none"> • The electrical system may only be set up by qualified electricians. In this context, the regulations of DIN VDE series 0100 are fundamental. • The regulations of the local power supplier concerning the electrical connection (e.g. residual current circuit breaker, additional potential equalisation etc.) must be complied with. If in doubt, ask your electrician. • An intended choice of electrical cables and connectors must be used. • Mains voltage and mains frequency of the voltage supply must correspond to the parameters indicated on the identification plate of the device. • Do not connect a damaged device (e.g. damaged during transport) to the mains. • Contact your customer service, if you have any queries about the electrical connection, the features or the security of the humidifier. • Disconnect the device from mains, if it does not work perfectly or if damage has occurred. • Disconnect the device from mains, if the electrical supply line is damaged. • Work on the device may only be carried out as described in these instructions. • Never use high pressure cleaners to clean the device. • Use grease and oil-free materials only.
---	---

3. Scope of delivery

<p>Universal Humidifier UB-1...4/CT/3.1</p>  <p>Fig. UB-4/CT/3.1</p>	<p>Installation and operating instructions</p>  <p>Spare part list</p> 	
<p>Water filter for tube connection D/d = 6/4 mm and Stop cock Ø 6 mm</p>  <p>Item No. 0009178</p>	<p>Discharge tube UB-1...4 (comprising:) tube Ø 12 mm, elbow connection, T-connector, screw-on connector</p>  <p>Item No. 0009085</p>	
<p>Schuko power cable IEC 2m</p>  <p>Item No. 0001773</p>	<p>SUB-D Connector male, 15-pole, housing</p>  <p>Item No. 0002865</p>	

4. Optional accessories

Item no.	Type	Description	Illustration
0001144	Tube, PE D/d=6/4 blue	Tube water supply D=6mm (blue)	
0001197	Tube, PE D/d=12/9 black	Tube water drainage D=12mm (black)	
6100096	BO-120/1	Room hygostat for ON/OFF control of the humidification system, 1-stage	
8005062	BO-RO-6/UV-EC	Reverse osmosis system 6 l/h with permeate storage tank, UV treatment and U-beam, powder-coated. Other models on request.	
2001130	Leakage tray for UB-1..4	with flanged sockets, made of V2A stainless steel with 3D surface (glossy)	



Item no.	Type	Description	Illustration
0001327	Aerosol tube	IW = 40 mm, made of PU with plastic spiral, microbe and hydrolysis resistant, -30 °C to +90 °C, black	
0003503	Hose bracket	for aerosol tube Ø 40 mm	
2010005	Aerosol jet 63 NCH	Aerosol distribution pipe 524 mm long with 12 drill holes	
2010004	Aerosol jet 125 NCH	Aerosol distribution pipe 1149 mm long with 24 drill holes	
2001118	Hose adapter 75	screwed to the suction side, $D_{outer} = 76$ mm, made of V2A stainless steel, for hose or HT pipe 75 mm	
2001119	Hose adapter 80	screwed to the suction side, $D_{inner} = 80$ mm, made of V2A stainless steel, suitable for reduction DN 100/80	
2001205	Reduction DN 100/80	DN 100/80, galvanised, with seal, in connection with hose adapter 80	
2001206	Aluminium flexpipe	DN 100, compressed approx. 42 cm, expandable to 10 m	
2001201	Filter box G4	with connection Ø 100 mm, filter class ISO coarse 50% (G4)	
2001202	Filter box M6	with connection Ø 100 mm, filter class ISO ePM10 70% (M6)	

5. General information

5.1 Technical terms

Transducer	:	Piezo ceramic transducer
Aerosols	:	Finely distributed material (solids or liquids) in air or other gases, manifestations are e.g.: in smoke, dust, vapour and fog
Demineralised water	:	Pure water, permeate
Concentrate	:	Concentrated water, waste water of reverse osmosis system

5.2 Physical principles of piezo ceramics

If certain crystals are deformed by mechanical stress, electrical charges will build up proportionally on their surface, producing electric field strength in the crystal.

This effect was discovered by Pierre and Jacques Curie in 1880. Even the reversal of this so-called piezoelectric effect or piezo-effect is possible. The same materials change their dimensions under the influence of an electric field.

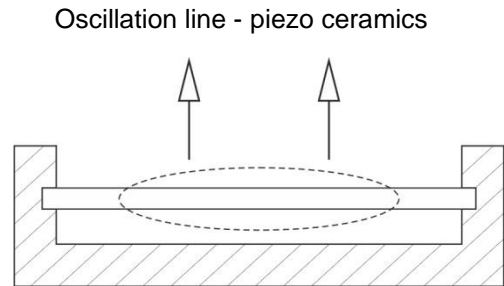

Fig. 1 - Schematic sketch of piezo-effect

Ceramic piezoelectric materials are hard, chemically inactive and completely insensitive to humidity or other atmospheric influences.

5.3 Functional description - ultrasonic air humidifier

All frequencies above 20,000 Hz are called ultrasonic.

According to their physical nature, acoustic waves consist of mechanical oscillations of compressible media. These oscillations develop due to the deflection of the particles of a compressible material from their equilibrium position. Acoustic waves are bound to a medium and thus do not occur in the vacuum.

Oscillations develop as a result of a change in pressure. Repeated pressure increase and pressure reduction produce different acoustic waves.

In order to be able to use ultrasonic waves for air humidification, electrical energy must be converted into mechanical energy. This takes place in the piezoelectric transducer.

A vibration unit consists of the resonance circuit where the high frequency of ~ 1.7 MHz is produced and the piezoelectric transducer to convert the electrical frequency into a proportional mechanical oscillation. This frequency is not audible for human beings or animals.

The piezoceramic transducers are attached to the bottom of the fluid tank. During excitation of the transducer, the water leads the ultrasonic vibrations to the boundary layer between water and air. Constant compression and decompression of the water gauge over the transducer causes cavitation in the immediate proximity of the water surface. Thus, crossing capillary waves are developed, the finest water particles of which, the aerosols, are produced in the wave crest.

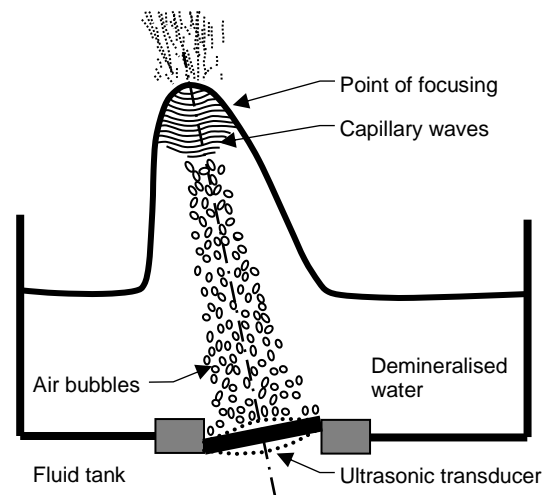

Fig. 2 - Schematic sketch aerosol production

The aerosols are delivered by the air flow in the humidifier and quickly mix with the ambient air. They have a small diameter (0.001 - 0.005 mm) and thus form a freely floating mist. The droplet diameter depends on the surface tension and the density of the medium, but also on the excitation frequency. The higher the excitation frequency, the smaller is the diameter of the droplets.

6. Advantages of ultrasonic air humidification

- 1. maximum energy saving**

Compared to steam and infrared humidifiers with the same humidification output, ultrasonic air humidifiers need up to 93 % less electricity.
- 2. lowest connected load**

Compared to electrode steam humidifiers with the same humidification output, only approx. 7 % of the power input is required. Thus, lower third-party connection costs are possible.
- 3. energy-saving cooling effect**

During humidification with the ultrasonic air humidifiers, the room air is cooled at the same time due to the adiabatic humidification principle. The result is a lower heat load reducing the cooling output requirements.
- 4. lowest water consumption**

Nebulizer humidifiers lose up to 70 % of the water, steam humidifiers up to 30 %. AIRWIN® Ultrasonic air humidifiers do not have any water loss apart from the cyclical emptying process of the fluid tank on AquaDrain.
- 5. immediate max. humidification**

Simultaneously with the request impulse, humidification is carried out without any delay.
Exception: during automatic drainage and line flushing.
- 6. max. evaporation of the water**

Ultrasonic air humidifiers produce a very fine aerosol mist. On average, the diameter of the aerosols is only 0.001 - 0.005 mm. Thus, the mist spreads quickly and is taken up by the air after a very short time

7. Device overview

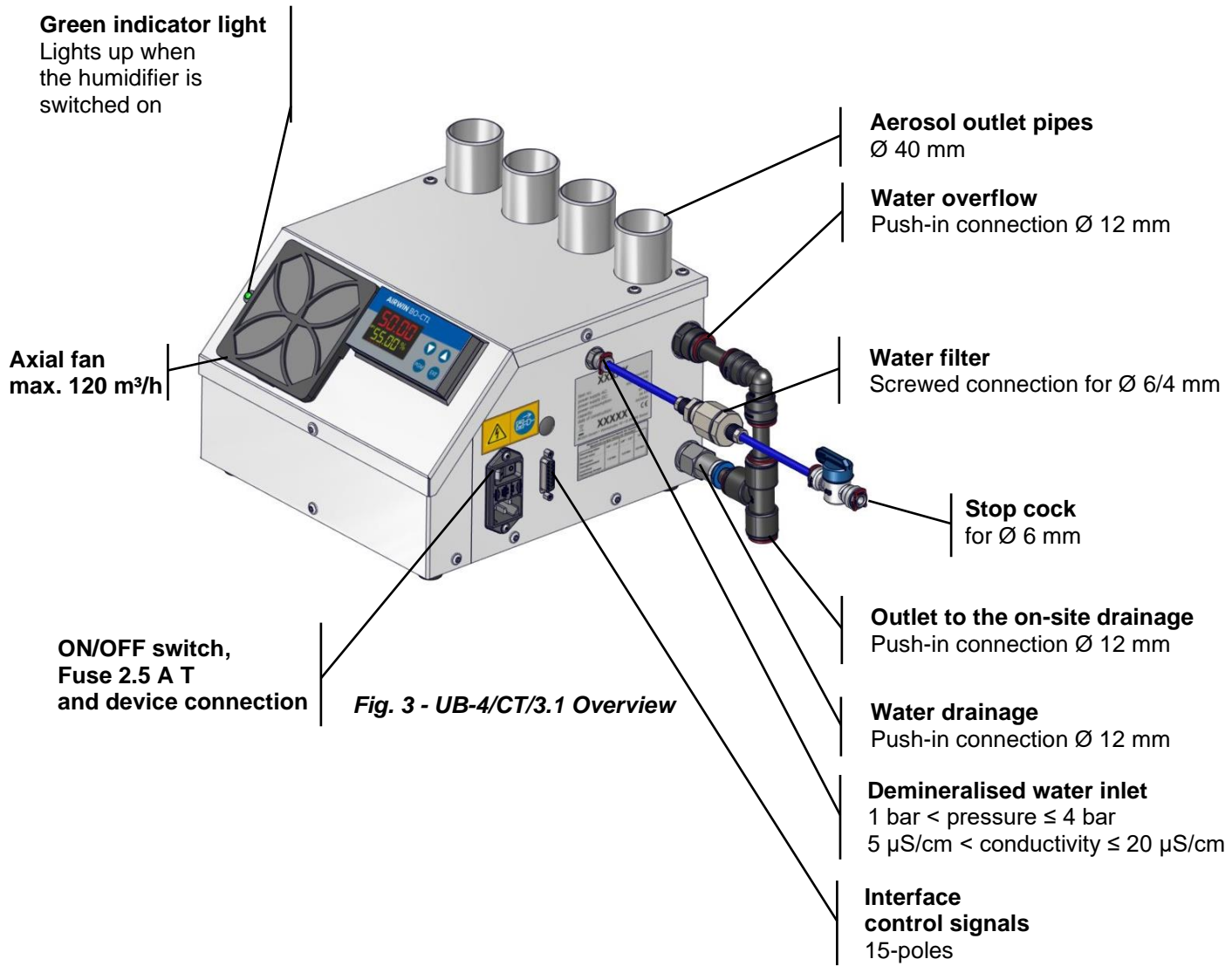

7.1 The UB-1...4/CT/3.1-System

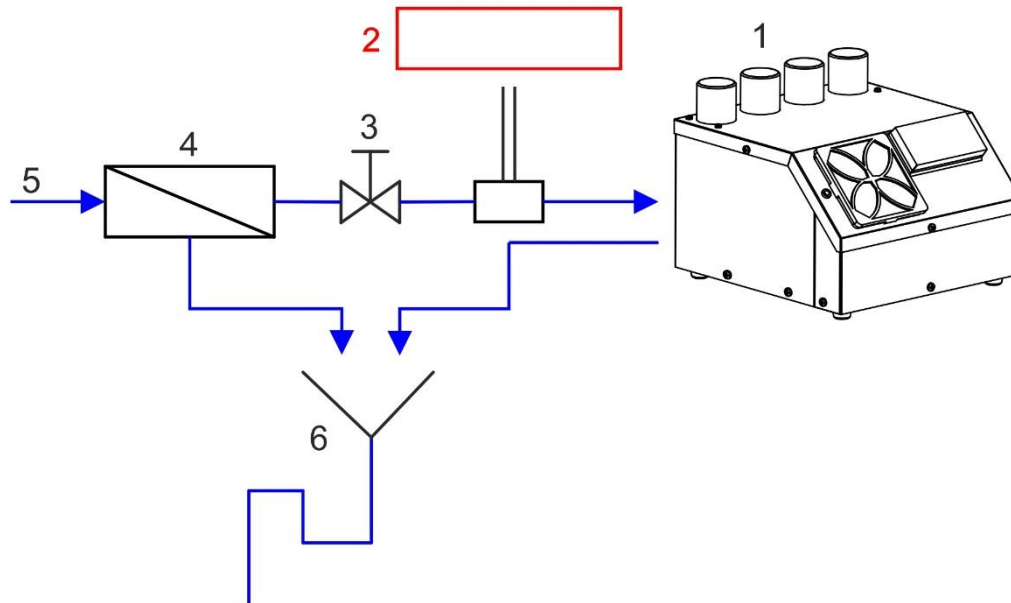

Fig. 4 - Schematic illustration of UB-4/CT/3.1 humidification system

Definitions

1. UB-4/CT/3.1
2. Stop cock (included in the scope of delivery)
3. Conductivity meter (e.g. CM-1) to check the quality of the demineralised water
4. Reverse osmosis system (see BOGA product range)
5. Drinking water supply (on site)
6. Free discharge according to DIN 1988-100 (on site)
7. External control (hygostat or continuous control signal - see BOGA product range)

8. Installation conditions

Correct installation in accordance with the following instructions ensures trouble-free operation of the device.



The device must not be exposed to large temperature differences during installation, otherwise there is a risk of condensation forming inside the device. This can lead to a failure of the electronics.

- Visual checks of the device at the installation site should be possible.
- The installation site must allow for simple assembly and disassembly of the device for maintenance and inspection purposes.
- The device must be installed exactly in the horizontal position to ensure that the water level is the same **above ALL** ultrasonic transducers.
- Automatic drainage of the fluid tank and automatic flushing of the demineralised water pipeline require that a free discharge exists in accordance with DIN 1988-100.
- The humidity sensor must be positioned in such a way that it is located in the area of the humidifier, but that direct influence by the aerosol flow of air is excluded.
- The stainless steel outlet pipes for the aerosol mist have a diameter of 40 mm and are located so far away from each other that it is possible to connect commercially HT pipes with integrated lip seals. The extensive delivery range of HT pipes provides cost-favourable, fast and highly flexible aerosol guidance; so it is also possible to combine aerosol outputs.



Do not use any greasy lubricants for the installation of the aerosol pipes and tubes, because that would change the surface tension of the water and nebulisation would no longer be possible!



The interior areas of the device should always be protected against pollution! (Air filter boxes see optional accessories)

9. Aerosol distribution systems

Basic conditions:

1. The humidifier must always be operated **with** an external aerosol distribution system (tube/pipe).
2. Aerosol distribution may not be done in such a way that the device sucks the aerosols in again through the built-in axial fan and thus works in the aerosol short circuit. As a result, the device could be damaged.
3. For aerosol distribution, all pipes/tubes must be equally long.

9.1 Aerosol Jet

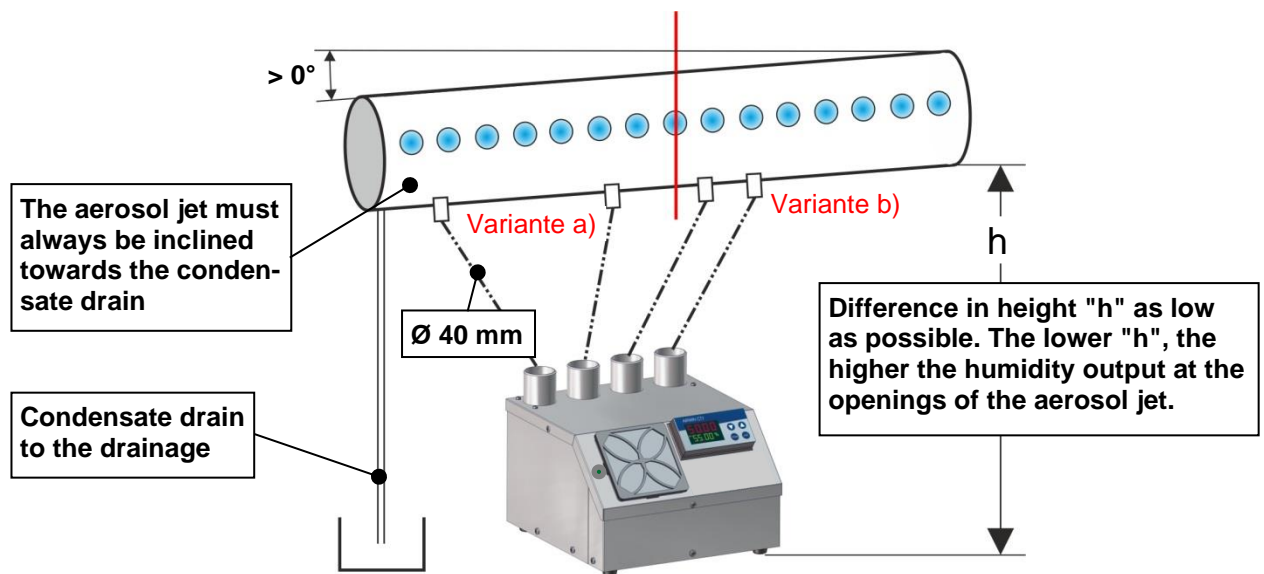

Fig. 5 - Aerosol Jet

The flexible tubes may be connected to the aerosol jet as shown in Fig. 5 in accordance with variants **a)** or **b)**. The optimal solution would be **a)**. In that case, aerosol density is the same along the length of the aerosol jet whereas in **b)** the aerosol density decreases nearly linearly towards the end of the aerosol jet.

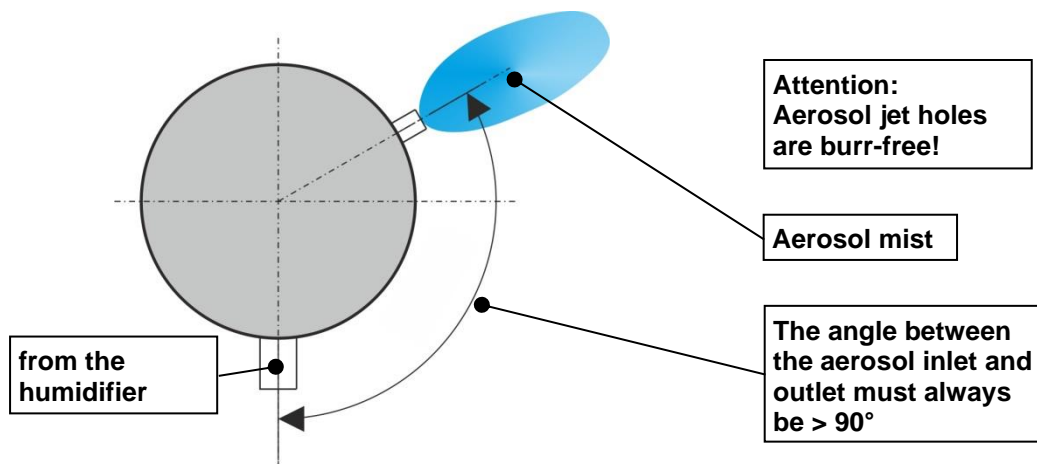

Fig. 6 - Cross-section of aerosol jet

9.2 Aerosol pipes

The aerosols may also be distributed without an aerosol jet. The transport of the aerosols is then done only via pipes or tubes directly to the place of humidification. This place may be in a different room, even in an aggressive environment.

Place of humidification

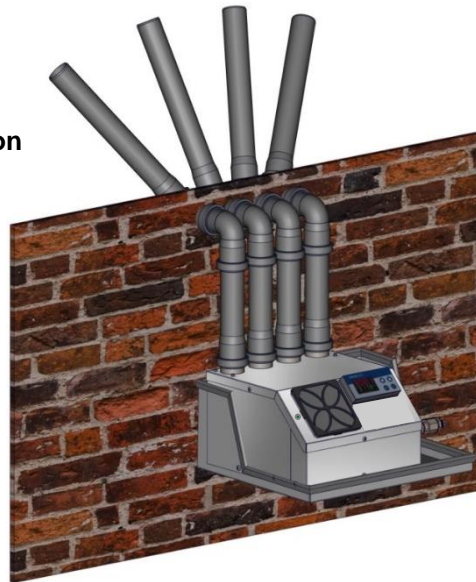

Fig. 7 - UB-4/CT/3.1 with pipes for aerosol transport



The pipes or tubes must be placed in such a way that the return of the condensate is always possible along the entire pipe / tube length. It must be ensured that the flow resistances of the individual exhaust systems are all the same.

9.3 Joined aerosol outlets



Fig. 8 - UB-4/CT/3.1 with joined aerosol outlets



Merging the aerosol outlets may result in a loss of power due to condensation.

10. Hydraulic connection

10.1 Hydraulic conditions

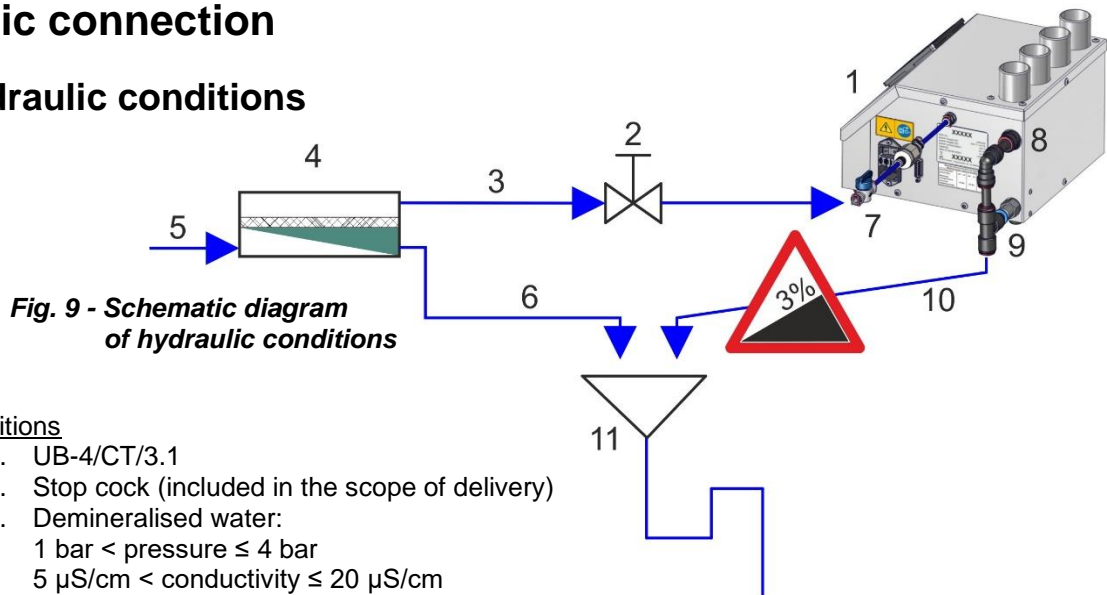



Fig. 9 - Schematic diagram of hydraulic conditions

Definitions

1. UB-4/CT/3.1
2. Stop cock (included in the scope of delivery)
3. Demineralised water:
1 bar < pressure ≤ 4 bar
5 μS/cm < conductivity ≤ 20 μS/cm
4. Water demineralisation system (reverse osmosis system)
5. Drinking water supply (on site)
6. Concentrate
7. Water supply for plastic tube Ø 6 mm
8. Water overflow for plastic tube Ø 12 mm
9. Water discharge for plastic tube Ø 12 mm
10. Water overflow hose
11. Free discharge according to DIN 1988-100 (on site)

Important notes:

- The humidifier may be operated with fully demineralised water only (produced for example by a reverse osmosis system). The demineralised water must have a conductivity of min. 5 μS/cm and max. 20 μS/cm.
- The contamination of drinking water may not exceed the max. values laid out in the drinking water regulations.
- The demineralised water is corrosive, therefore use stainless steel or plastic only. Non-ferrous metals (e.g. copper, brass) must not be used.
- Water pressure must be minimum 1 bar and maximum 4 bar.
- The drainage system on site must be set in accordance with DIN 1988-100.
- The water overflow- and discharge hose must be laid with a constant slope of min. 3% (3 cm on 1 m) to the free discharge.
- For easy revision, the stop cock included in the delivery must be installed in the demineralised water supply line close to the device.

	<p>All materials coming into contact with the demineralised water must be resistant to demineralised water (observe pressure and temperature resistance). Demineralised water pipes must be flushed prior to starting the device.</p>
---	---

10.1 Establishing and detaching the connections with connectors

The connectors provide durable, safe and watertight connections between tube and connecting element. The tube is simply inserted by hand. The retaining element holds the tube safely without pressing it or decreasing the flow.

Establishing the connection

Cut tube squarely and free of burrs.
Make sure that the tube has no sharp edges, longitudinal grooves or other damage.

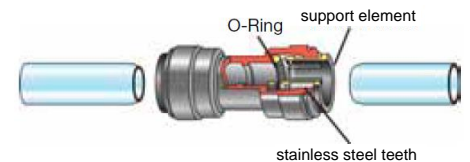

Fig. 10 - Establishing the connection

Connection is stable prior to sealing

Insert the tube up to the stop.
The supporting element holds the tube in the connector. With the help of the o-ring, a tight connection is established.



Fig. 11 - Insert tube

Check the connection by pulling towards the opposite side

By pulling towards the opposite side check whether the tube was safely inserted.
Then slide on the locking clip.

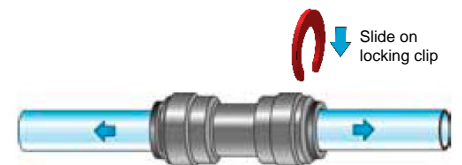

Fig. 12 - Check connection

Detaching the connection

First remove the locking clip.
The tube can be detached by pushing back the supporting element.

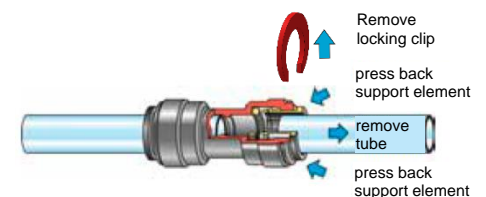

Fig. 13 - Detaching the connection

	<p>All pipes, tubes and connecting elements must be resistant to demineralised water.</p> <p>The surface hardness of pipes and tubes must not exceed 225 HV. Otherwise the retaining teeth in the connector do not securely hold on it.</p> <p>Soft tubes are also to be avoided.</p>
--	---

11. Electric connection

The electric connections of the humidifier are found on the side of the housing. Confusion is prevented by form-coded plugs.



Fig. 14 - Electric connection

11.1 Control connection

The 15-pole D-SUB connector must be used for the control signals for operating the humidifier.



Fig. 15 - 15-pole D-SUB connector



Tab. 11-1 - Connection diagram plug D-SUB 15-pin

Clamp	Shortcut	Funktion	Technical description interface
1	SI	Release humidification operation	Input for normally control contact safety chain
2	SI	Release humidification operation	Input for normally control contact safety chain
3	Error	Collective error message	Output potential-free contact fault status
4	Error	Collective error message	Output potential-free contact fault status
5	Operate	Operational message	Output potential-free contact operation status
6	Operate	Operational message	Output potential-free contact operation status
7	K1	Controller signal contact	Output potential-free contact, setpoint underrun
8	K1	Controller signal contact	Output potential-free contact, setpoint underrun
9	+ Ub	18 V Power supply sensor	Power supply + humidity sensor
10	- Ub	GND Power supply sensor	Power supply - humidity sensor
11	+ Signal	Analog input 0-10 V	Input + humidity sensor signal 0-10 V
12	- Signal	Analog input GND	Input - humidity sensor signal 0-10 V
13	RS-485 A	Interface RS-485	RS-485 Modbus A
14	RS-485 B	Interface RS-485	RS-485 Modbus B
15	RS-485 GND	Interface RS-485	RS-485 Modbus Com

11.1.1 Safety chain

Connect safety chain on the terminals marked 1 and 2 on the 15-pole plug.
Use potential-free contact.

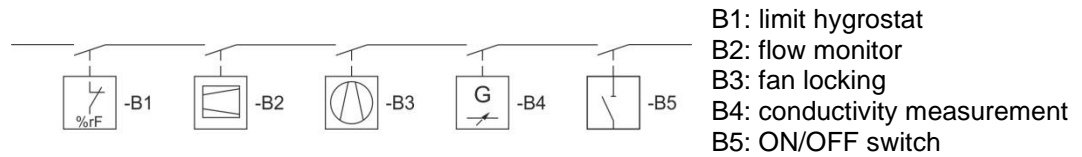

Fig. 16 - Safety chain

The input of the safety chain must always be connected to safety devices with an NC contact.
A cable bridge is always wired at the factory between connections 1-2 / safety chain.
The humidifier does **NOT** work otherwise.

If several humidifiers are connected to the safety chain, this must be isolated and connected to each humidifier with separate switching contacts.

11.1.2 Status Message Operation - Error

There are two signal outputs via PhotoMOS relay.



Fig. 17 - PhotoMOS Relais

Tab. 11-2 - Status messages operation / error

Status message	Message type	Connection terminal on 15-pole plug
1	Operational message	5 + 6
2	Collective error message	3 + 4

11.2 Device control

11.2.1 Continuous control - analogous input

Due to the integrated continuous controller CT1, no constant external control signal is necessary.

The analogous input (InP1) was set to 0-10 V linear signal in the factory. It is possible to adjust that value via measured value correction (OFFS), filter time constant (dF) to the corresponding measuring application.

The room humidity transmitter BO-FWL or BO-FK-80J duct humidity transmitter, from the optional accessories, is connected at **9(+)** and **10(-)** and for the power supply of the transmitter at **11(+)** and **12(-)** for humidity signal 0-10 V. Please make sure that connections are made with the correct polarity (+/-).

Tab. 11-3 - Connection of the BO-FWL

UB/CT/31.1	Transmitter	Signal
Pin 9	Pin 2	Voltage supply +18 V
Pin 10	Pin 1	Voltage supply 0 V
Pin 11	Pin 4	Humidity signal + U
Pin 12	Pin 3	Humidity signal GND



Fig. 18 - BO-FWL room humidity transmitter

11.2.2 Fault signal - value below set humidity value

With the limit comparator - limit signal of the continuous controller CT1 it is possible to generate a signal if the value falls below the set point value. Using the 10-poles connector terminal 5/6, a potential-free relay contact for external signalling is available. If the value falls below the limit value, the relay contact is closed and "Alrt" appears in the display. Changes in the limit comparator settings can be made in the controller configuration at LC1.

Default setting limit comparator → limit comparator (LC1)

Function (Funct)	:	lk 4
Limit value (AL)	:	15.00 (15% limit value below setpoint value)
Switching differential (HySt)	:	1,000
Hysteresis function	:	Symmetrical
Mode of action (AcrA)	:	Relative
Range behaviour (AcrA)	:	LK on
Acknowledgement (AcnL)	:	None
Switch-on delay (tOn)	:	350 s (switch-on delay AquaDrain influence)
Switch-off delay (tOFF)	:	0 s
Wiper time (tPuL)	:	0 s
LK actual value (LCPr)	:	Actual value
LK set point (LCSP)	:	Current set point

11.2.3 Control via Modbus RTU

The humidifier can be controlled via BOGA Modbus RTU both in on-off operation or in continuous operation.

Further information can be found in the BOGA Modbus RTU interface description. This can be requested from the manufacturer or viewed and downloaded from the www.boga.de website.

12. Operation

12.1 Setting of set point

The set point is set at the operating display of the continuous controller CT1. The desired set point is entered by pressing the up and down keys.

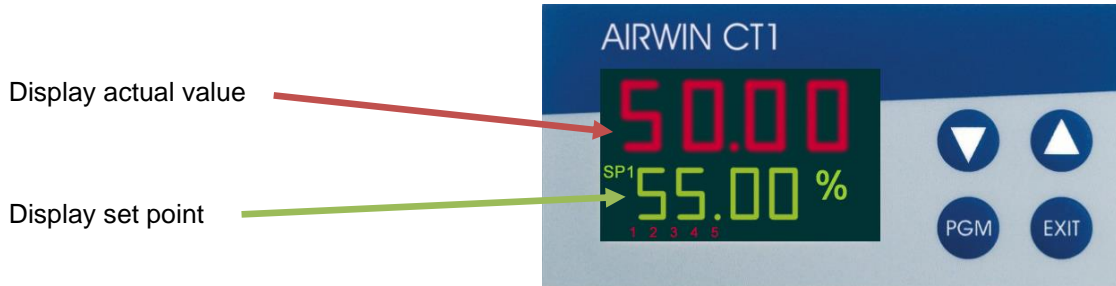

Fig. 19 - Continuous controller CT1

12.2 Level concept

The parameters for device setting are organised at different levels.

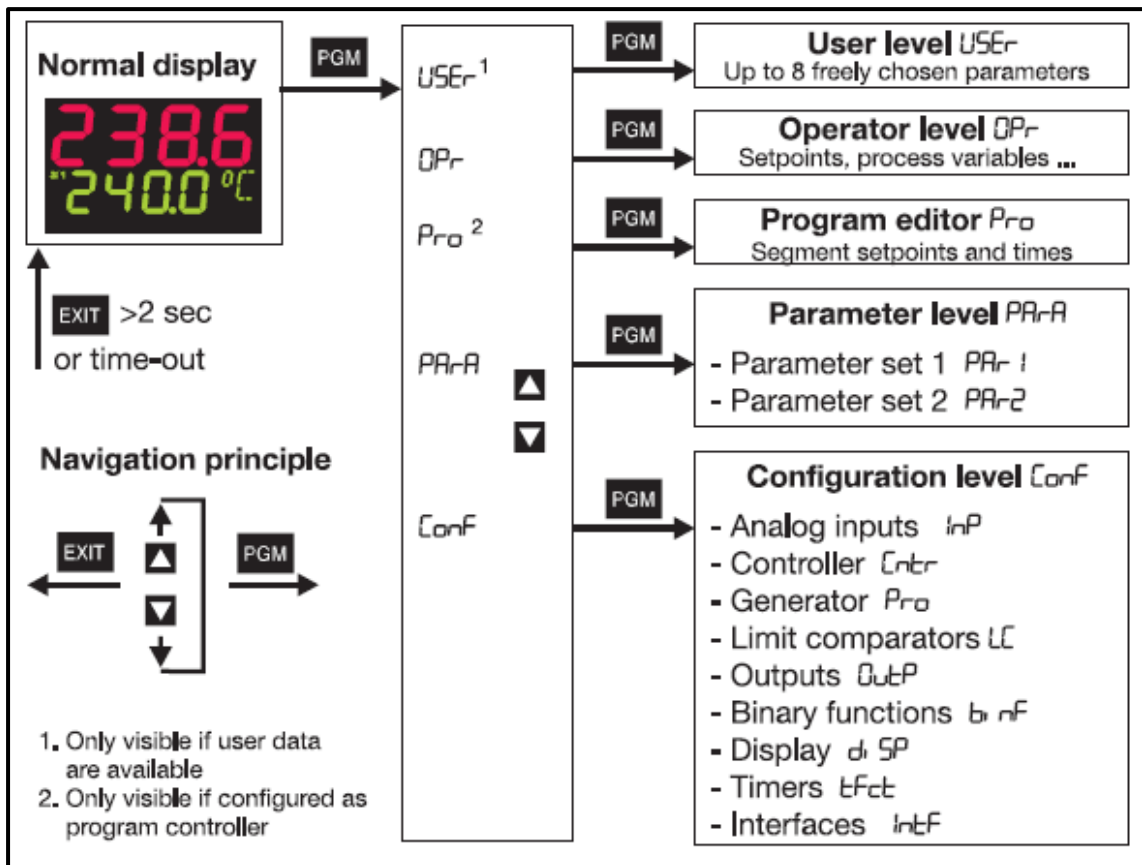

Fig. 20 - Configuration level

Time-Out: If no button is pressed for 180 seconds, the unit will return to the normal display!

12.3 Parameter level

		<i>PARA → PAR 1 (PAR 2)</i>		
	Display	Value range	Factory setting	Description
Proportional band	<i>Pb 1</i>	0...9999	0	Size of the proportional band
	<i>Pb 2</i>	0...9999	0	The gain of the controller decreases with increasing proportional band. With $Pb_{1,2} = 0$ the controller structure is ineffective (limit comparator response). Continuous controllers: $Pb_{1,2}$ must be >0 .
Derivative time	<i>dt</i>	0...9999 s	80 s	Influences the differential component of the controller output signal. The effect of the D component increases with increasing derivative time.
Reset time	<i>rt</i>	0...9999 s	350 s	Influences the integral component of the controller output signal. The effect of the I component decreases with increasing reset time.
Cycle time	<i>Cy 1</i>	0.0...999.9s	20 s	With a switched output, the cycle time should be chosen so that a) the pulsed energy flow to the process does not cause any impermissible PV fluctuations and b) the switching elements are not overloaded.
	<i>Cy 2</i>	0.0...999.9 s	20 s	
Contact spacing (dead band)	<i>db</i>	0.0...999.9	0	The spacing between the two control contacts for 3-state or modulating controllers.
Switching differential	<i>HyS 1</i>	0.0...999.9	1	Hysteresis for switching controllers with $Pb_{1,2} = 0$.
	<i>HyS 2</i>	0.0...999.9	1	
				
Actuator time	<i>tt</i>	5...3000 s	60 s	Actuator time range used by the control valve for modulating controllers.
Working point	<i>y0</i>	-100...+100%	0%	Output for P and PD controllers (when $x = w$ then $y = y0$).
Output limiting	<i>y 1</i>	0...100%	100%	Maximum output limiting.
	<i>y 2</i>	-100...+100 %	-100%	Minimum output limiting. (only effective with $PB>0!$)

Fig. 21 - Parameter level

The parameters Pb_2 , Cy_2 , HyS_2 refer to second controller output for a 3-state controller.

The decimal place of some parameters depends on the decimal place setting in the displays

→ The parameter display on the instrument depends on the selected controller type.
(see Jumo manual Chapter 8.2 "Controller" (Cntr))

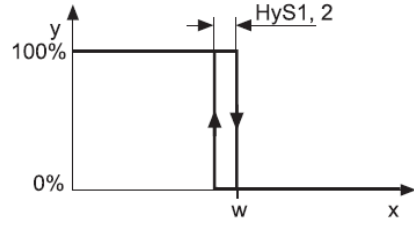
12.4 Autotuning (self-optimisation)

Autotuning (self-optimisation, SO) establishes the optimum controller parameters for a PID or PI controller.

Depending on the controller type, the following controller parameters can be defined: Reset time (rt), derivative time (dt), proportional band (Pb), cycle time (Cy), filter time constant (dF)

The controller selects one of two procedures (**a** or **b**), depending on the size of the control deviation:

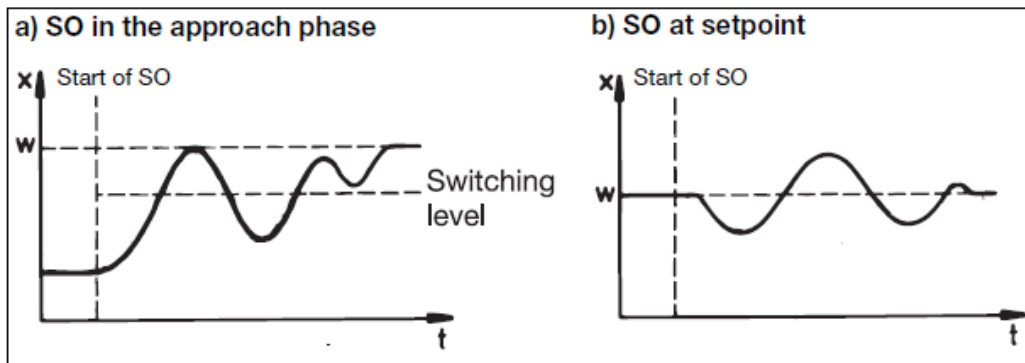

Fig. 22 - Self-optimisation



Starting auto-tuning	<ul style="list-style-type: none"> * Start with ▲ and ▼ (simultaneously >2sec "tUnE" is shown, blinking, in the lower display) <p>Autotuning is ended when the display automatically changes over to normal display. The duration of autotuning depends on the control process.</p>	
Canceling auto-tuning	<p>☞ The type of controller outputs has to be defined for autotuning. ⇒ Chapter 8.2 "Controller "Cntr""</p> <p>For a device configured as program controller, the autotuning can only be started if no program is running (normal display). In case of problems, you may find further information at www.jumo.net (Support/FAQ).</p> <ul style="list-style-type: none"> * Cancel with ▲ and ▼ (simultaneously) 	

Fig. 23 - Start self-optimisation

	<p>In the supplied instructions for the continuous controller CT1, more information, settings and detailed specifications are provided.</p>
---	---

13. Structure and functions of the control board AIRWIN 3.1

13.1 Connections

Inputs

X9 - Connection of float switch:

- 1: Float switch, level "S1" black
- 2: Float switch, level "S1" brown
- 3: Float switch, level "S1" blue
- 4: Float switch, level "S1" grey

- 5: Float switch, level "S2" black
- 6: Float switch, level "S2" brown
- 7: Float switch, level "S2" blue
- 8: Float switch, level "S2" grey

X8 - Connection sensor:

- 1: Current measurement -
- 2: Current measurement +

Notice:
Only connections relevant to the device are shown.

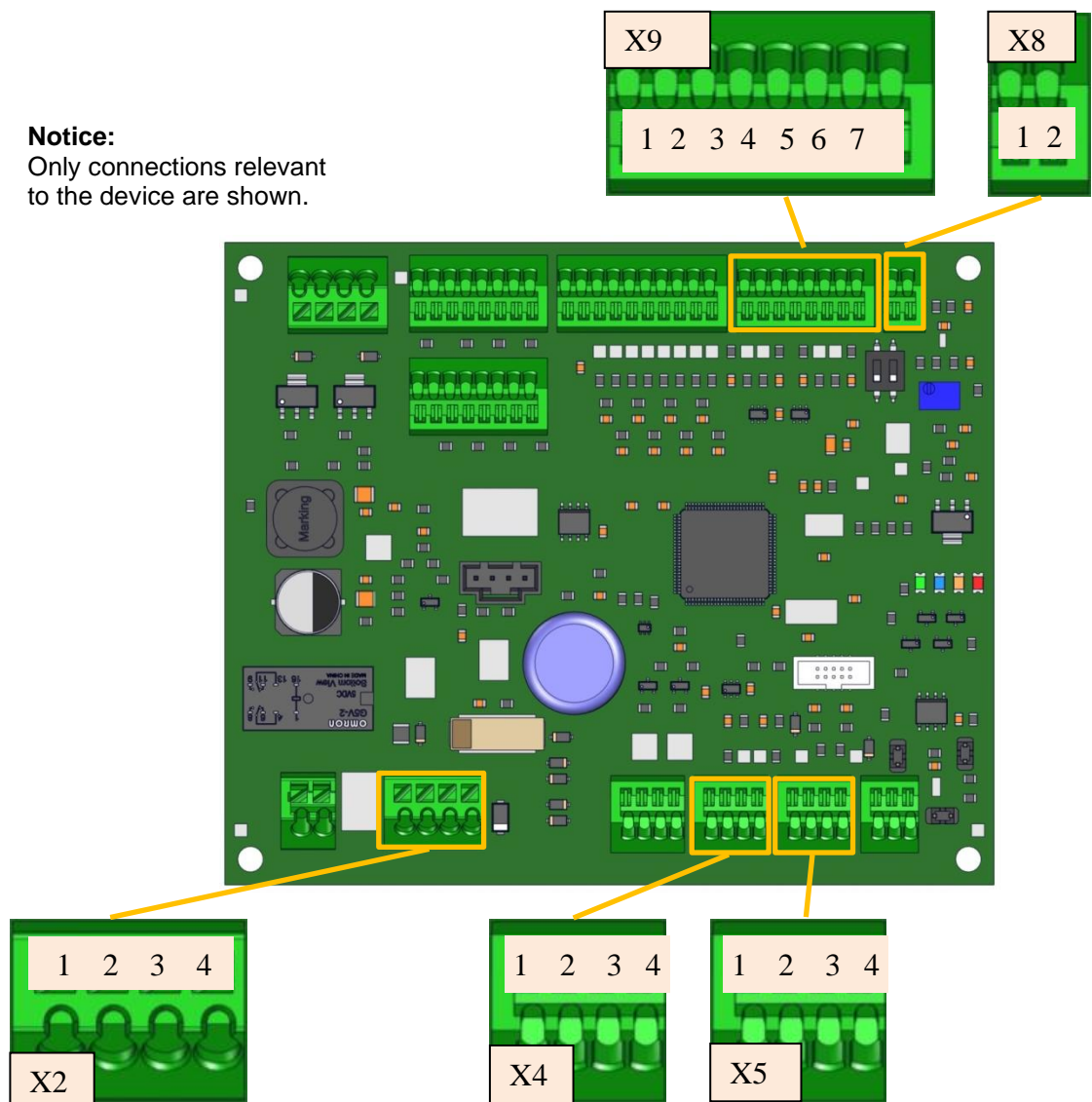

Fig. 24 - Control board PCB AIRWIN 3.1 Input

X2 - Connection to supply:

- 1: Power supply L 48 V-AC
- 2: Power supply N 48 V-AC
- 3: Release 48 V-AC, 24 V-DC
- 4: Release 48 V-AC, 24 V-DC

X4 - Connection hyg:

- 1: Hygrostat input 1
- 2: Hygrostat input 1
- 3: Hygrostat input 2
- 4: Hygrostat input 2

X5: - Connection Reg:

- 1: Control signal mA + (Ri: 500 Ω)
- 2: Control signal mA -
- 3: Control signal V + (Ri: 50 kΩ)
- 4: Control signal V -

Outputs

X7 - Connection of solenoid valves

- 1: Solenoid valve drain L+
- 2: Solenoid valve drain N-
- 3: Solenoid valve supply L+
- 4: Solenoid valve supply N-

X12 - Connection of oscillator boards:

- 1: PWM 4 - 5: PWM 2 -
- 2: PWM 4 + 6: PWM 2 +
- 3: PWM 3 - 7: PWM 1 -
- 4: PWM 3 + 8: PWM 1 +

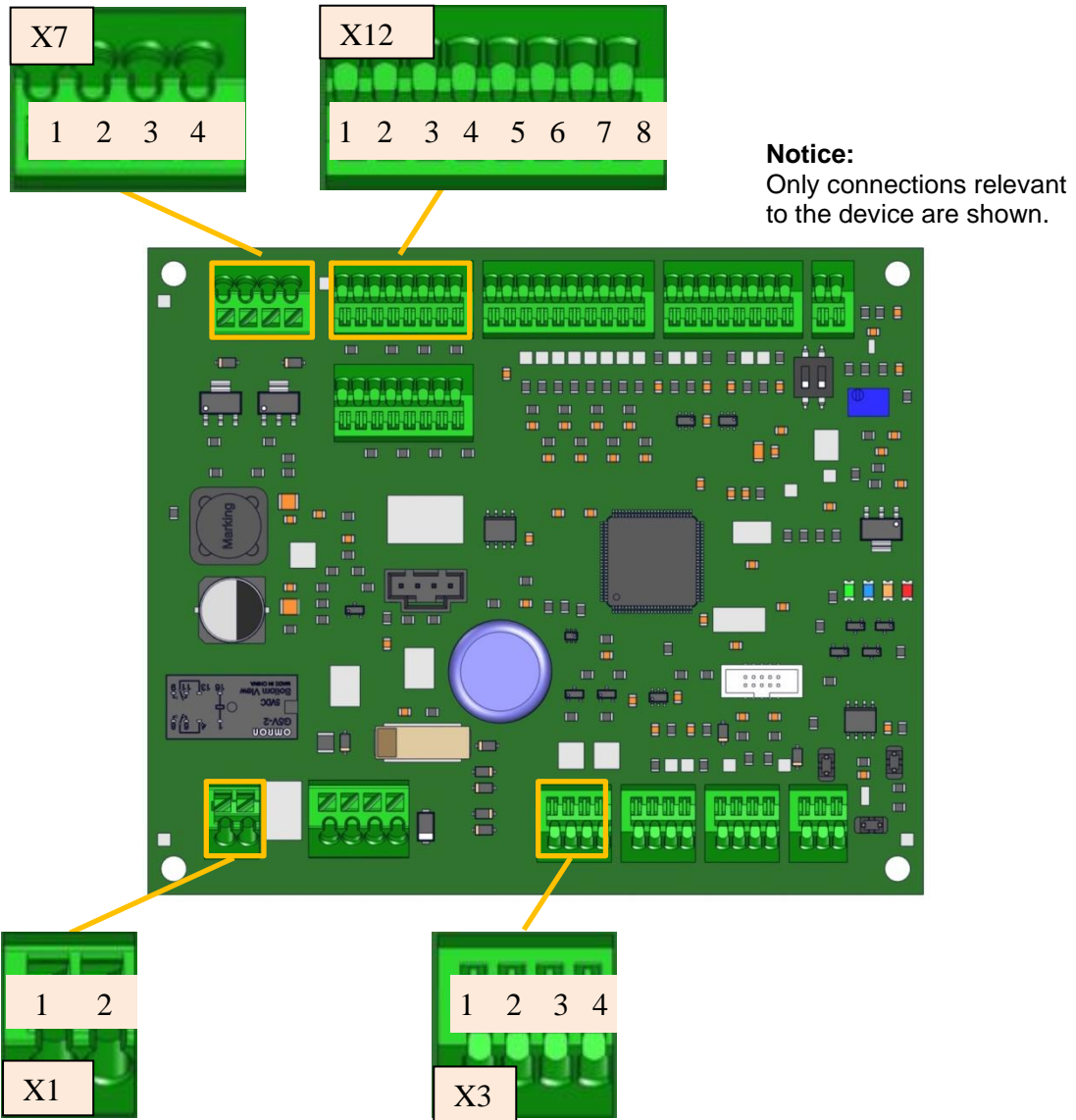

Fig. 25 - Control board PCB AIRWIN 3.1 Outputs

X1 - Connection Fan:

- 1: Relay closing contact
- 2: Relay closing contact

X3 - Status reports:

- 1 + 2: Status message 1 (Operation)
- 3 + 4: Status message 2 (Error)



13.2 Functional description of the controller

Current measurement of the oscillator boards

In this configuration, a current check of the oscillator boards is performed every 3 hours. **This test only takes place when the humidification request is present and lasts max. 5 seconds. During this time, the humidifying power is set to 100% and a functional test of all transducers is performed.**

Change of the level control

Since the level control in the humidifier is an important control, the two existing level float switches are monitored simultaneously. A digital evaluation of the states of both float level levels reliably detects critical and impermissible states.

Check and holding voltage of the solenoid valves

The current consumption of the solenoid valves is checked before and during filling. If a fault is detected, contact "collective error message" is closed.

Further monitoring-routines

Optionally there are monitoring routines for the filling (maximum filling time) and monitoring routines for emptying the fluid tray (maximum drainage time). If a fault is detected, an automatic problem-solving routine will attempt to correct this fault. Furthermore, it is possible to monitor the function of the fan, solenoid valve supply and solenoid valve drain via a current measurement.

If a system component does not work correctly, contact "collective error message" is closed.

The default settings of the control board AIRWIN 3.1 are shown in Tab. 13-1.

13.3 Standard Settings

Tab. 13-1 - Default settings PCB AIRWIN 3.1

	Parameter	UB-1...4/CT/3.1
Time Constants	AquaDrain Duration	3 minutes
	AquaDrain Cycle Time	12 hours
	AquaDrain Delay	disabled
	Flush Time	30 seconds
	Inactivity Flush Timeout	12 hours
	Inactivity Drain Timeout	3 hours
	Humdification Timeout	disabled
	Fill Timeout	15 minutes
Current Measurement	Inlet Valve	enabled
	Outlet Valve	enabled
	Fan	enabled
	Oscillator	25 %
	Oscillator Check Intervall	3 hours
IOs	Voltage Input Scale	0-10 V-DC
	Voltage Input Functionality	active
	Current Input Scale	4-20 mA
	Current Input Functionality	active
MOD BUS	Functionality	enabled
	Adress	Serial-No.Code
	Speed	19200 Baud

13.4 Settings

AquaDrain Duration:

The AquaDrain duration is the time the humidifier needs to empty the fluid tray. This value is given by design and depends on the type of humidifier, the size of the fluid tray and the installation.

Possible settings: 30 seconds, 1 minute, 2 minutes, 3 minutes, 4 minutes, 5 minutes, 6 minutes.

Default setting: 3 minutes

AquaDrain Cycle Time

The AquaDrain cycle time is directly linked to the automatic emptying of the fluid tray. The AquaDrain process is also performed when there is a humidification request.

Possible settings: Disabled, 10 minutes, 30 minutes, 1,5 hours, 3 hours, 6 hours, 12 hours, 24 hours, 48 hours.

Default setting: 12 hours

AquaDrain Delay

The AquaDrain delay is used when several humidifiers are mounted in a system and AquaDrain is enabled. The AquaDrain delay prevents all humidifiers from being emptied at the same time.

Possible settings: No delay, 1x 15 minutes, 2x 15 minutes, 3x 15 minutes, 4x 15 minutes, 5x 15 minutes, 6x 15 minutes, 7x 15 minutes

Default setting: No delay

Flush Time

The flushing time is the time at which the water supply line is flushed before the first operation and after a certain period of inactivity.

Possible settings: 15 seconds, 30 seconds, 120 seconds, 200 seconds

Default setting: 30 seconds

Inactivity Flush Timeout

If no humidification is requested, the humidifier is in standby mode. If the fluid tank is still filled, it is automatically emptied after the adjustable time "Inactivity Drain Timeout"..

Possible settings: Default setting, 10 minutes, 30 minutes, 1,5 minutes, 3 hours, 6 hours, 12 hours, 24 hours, 48 hours.

Default setting: 12 hours

Inactivity Drain Timeout

If no humidification is requested, the humidifier is in standby mode. If the fluid tank is still filled, it is automatically emptied after the adjustable time "Inactivity Drain Timeout".

Possible settings: Default setting, 10 minutes, 30 minutes, 1,5 hours, 3 hours, 6 hours, 12 hours, 24 hours, 48 hours.

Default setting: 3 hours

Humidification Timeout

The humidification timeout is implemented to check for possible water quality errors. If the humidifier operates for an adjustable amount of time and does not refill, the water may be dirty and can not be misted. When the "Humidification Timeout" time has elapsed, the humidifier checks the function of the level switches, empties the liquid tank and refills it to remove the contamination. Another cause of this error could be a lack of airflow. This problem-solving process runs three times. If the problem-solving process is unsuccessful, the humidifier will enter the error mode and display the "Humidification Timeout" error.

Possible settings: Disabled, 5 minutes, 30 minutes, 1,5 minutes, 3 minutes, 6 hours, 12 hours, 24 hours, 48 hours.

Default setting: Disabled

Fill Timeout

The "Fill Timeout" is the time the humidifier needs to fill the fluid tray. When the time for filling expires, without reaching the necessary fluid level in the fluid tray, a fill error has occurred and a problem solving routine is activated. If the error cannot be cleared, the humidifier displays the "Filling Error". The time to fill depends on the water supply pressure and the type of humidifier.

Mögliche Einstellungen: Deaktiviert, 5 minutes, 10 minutes, 15 minutes, 30 minutes, 60 minutes.

Standard Einstellung: 15 minutes

Oscillator Check Intervall

The oscillators can be automatically checked after a certain time. If the time interval has expired and a humidification request is present, the humidifier will operate for a short time (approximately 5 seconds) with 100% humidification performance.

Possible settings: Disabled, 5 minutes, 10 minutes, 15 minutes, 30 minutes, 1,5 hours, 3 hours, 6 hours, 12 hours, 24 hours, 48 hours.

Default setting: 3 Stunden

Changes to the default values can be made by prior arrangement presettled ex works.

13.5 State diagram

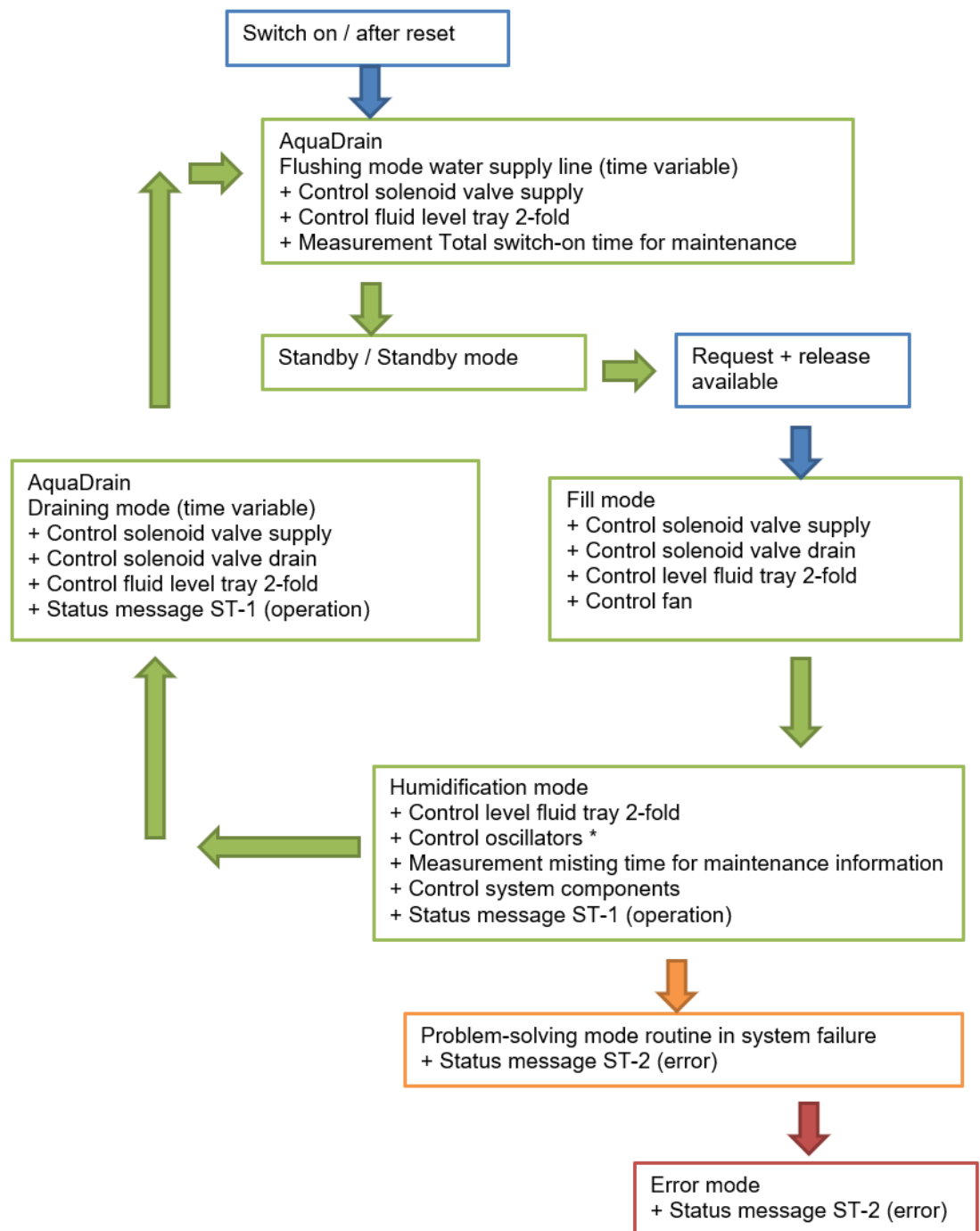

Fig. 26 - State diagram

*: During the control passage "Oscillators" is in the humidification mode automatically for **max. 5 sec. nebulisation power to 100%** booted.

13.6 Status messages

Tab. 13-2 - Status messages - System States

System State	Operational message
Device switched off no supply voltage	Contact open
Humidification activ	Contact closed
Humidifcation inactiv	Contact open

System State	Error message
Device switched off / no supply voltage	Contact open
Normal operation	Contact closed
Fault Mode – Error Mode	Contact open

13.7 LED-Indicator and decoding

There are 4 different colored LEDs on the control board humidification. Using different flashing and light frequencies all system states are displayed here.

Information about the next service (5,000 working hours) or maintenance interval (10,000 working hours) is also displayed here.

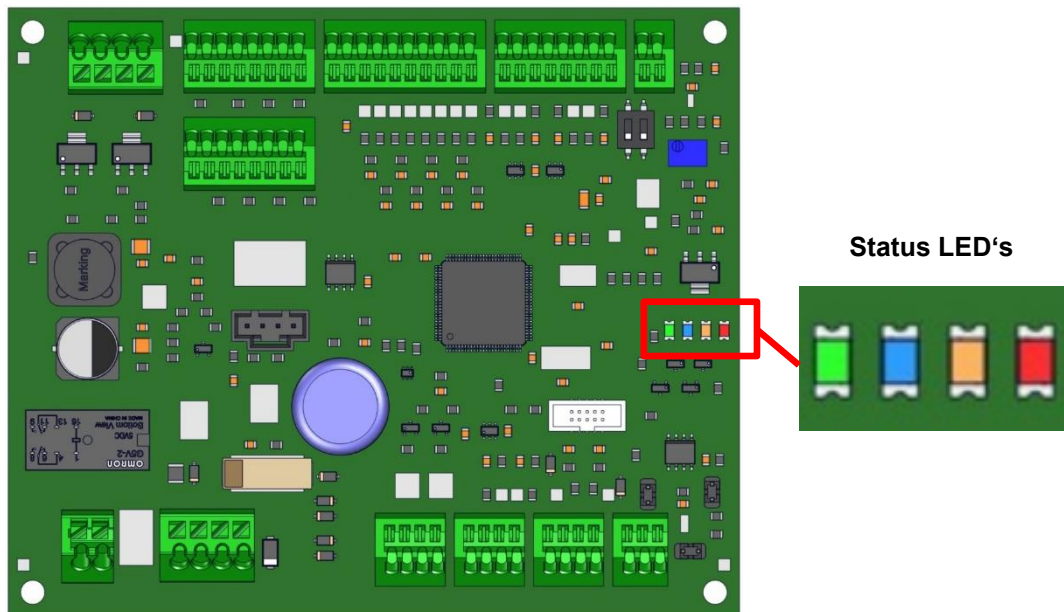

Fig. 27 - Control board AIRWIN 3.1

LED green	LED blue	LED orange	LED red		
		1	1	Fehler Füllen (Füllen Timeout) Error filling (Fill Timeout)	Fehlercode / error code
		2	1	Fehler Entleeren (Entleeren Timeout) Error draining (Drain Timeout)	
		1	∞	Fehler Strommessung Magnetventil-Zulauf Error current measurement supply valve	
		2	∞	Fehler Strommessung Magnetventil-Ablauf Error current measurement drain valve	
		3	∞	Fehler Strommessung Lüfter Error current measurement fan	
		4	∞	Fehler Strommessung Oszillatorplatinen Error current measurement oscillator boards	
		3	1	Fehler Vernebelung Timeout Error nebulisation timeout	
		4	1	Fehler Niveauschalter Error level switch	Zustand / status
∞			3	Bereitschaft (keine Freigabe & keine Anforderung) Standby (no release & no requirement)	
∞		∞		Vernebelung Nebulisation	
∞		1		Problemlöseroutine Problem solving	
∞		2		Spülung Flushing	
∞		3		Entleeren Draining	
∞		4		Wanne auffüllen & Lüfter Vorlauf Fill tank & fan pre-run	Wartung / maintenance
	1			Wartung 1 (5.000 Std.) Maintenance 1 (5,000 hours)	
	∞			Wartung 2 (10.000 Std.) Maintenance 2 (10,000 hours)	
∞			1	Befeuchtungsanforderung nicht vorhanden Humidification request not available	
∞			2	Freigabe nicht vorhanden Release not available	
		4	4	Unbekannter Fehler Unknown error	

Die Zahl gibt die Anzahl der Lichtimpulse der LED an. The number indicates the number of light pulses of the LED.
 ∞ = dauerhaft an ∞ = permanently on

Fig. 28 - Decoding LED-Display

13.8 Resetting the maintenance interval

The resetting of the LED display may only be carried out by trained specialists.
 After service or maintenance has been carried out, the LED display can be reset as follows:

1. Switch off the device and let it drain.
2. Remove the housing cover.
3. Deactivate the safety chain by removing the plug 15 poles.
4. Switch on the device, wait for the rinsing cycle and the AquaDrain Duration.
5. Do the following action 5 times in a row. Raise level switch S2 to the upper level, wait 1 second and then move it back to the lower level.
6. If the reset of the maintenance interval successful, the LED has gone out.
7. If the LED does not go out, repeat the process.
8. Put the housing cover back on and activate the safety chain.

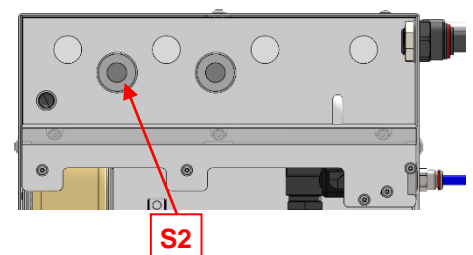

Fig. 29 - Levelswitch S2

13.9 Troubleshooting

Tab. 13-3 - Troubleshooting checklist

Error	Displayed error	Significance	Check installation	Check	Check control system	Elimination
No humidification	Error filling	The device is not filled within the specified time	Check inlet water pressure > 1 bar	Check water sieves	Check control unit settings	Restart humidifier
	Error draining	The device is not emptied within the specified time	Free drain available?	Check fluid tank for cleanliness and clean if necessary Function magnetic valve, check sequence	Check control unit settings	Restart humidifier
	Error current measurement supply valve	The solenoid valve inlet is not activated	Solenoid valve coil connected?	Function magnetic valve, check inlet	Check control unit settings	Restart humidifier
	Error current measurement drain valve	The solenoid valve drain is not activated	Solenoid valve coil connected?	Function magnetic valve, check discharge	Check control unit settings	Restart humidifier
	Error nebulisation timeout	A refilling of the fluid tank did not take place during the specified duration (humidification timeout)	Water quality in accordance with technical specifications? Air flow available?	Function magnetic valve, check inlet Cleaning the fluid tank and level switch	Check control unit settings	Restart humidifier
	Error level switch	Level switch values are not plausible	Check exact horizontal installation	Check fluid tank for contamination. Check level switch functions		Restart humidifier Change level switch
	Unknown Error	Unknown error	Check connection of the device	Check for visual defects	Check control unit settings	Disconnect the power supply for at least 1 minute and then restart
Humidification performance dropped	Error current measurement oscillator boards	The power of the oscillators deviates from the reference value outside the tolerance range	Optical control of the transducer.	Check the function of the transducer visually Check service status	Check control unit settings	Restart humidifier

14. AquaDrain plus - hygiene management

14.1 Description

AquaDrain plus is a system designed to flush the demineralised water inlet pipe to the humidifier according to various parameters and to cyclically empty the fluid tank of the humidifier. To do so, AquaDrain plus uses a certain software and a solenoid valve combination integrated in the housing of the humidifier. In addition, AquaDrain plus prevents that the fluid tank is refilled with water, which had been reduced by evaporation, during the humidification-free periods of the AquaDrain plus cycle.

The AquaDrain plus cycle is the cycle in which the humidifier, minus the time for flushing the water inlet pipe and drainage of the fluid tank, can humidify continuously, but does not necessarily have to do so. The AquaDrain cycle is 12 hours and the cycle was preset in the factory. Optionally this setting may be changed by the manufacturer to 48 h, 24 h, 6 h, 3 h, 1.5 h and 0.75 h.

Definitions

- 1. Humidifier
 - 1.1. Solenoid valve drain, integrated
 - 1.2. Solenoid valve supply, integrated
- 2. Water overflow
- 3. Water supply
- 4. Demineralisation system (reverse osmosis system)
- 5. Water drainage

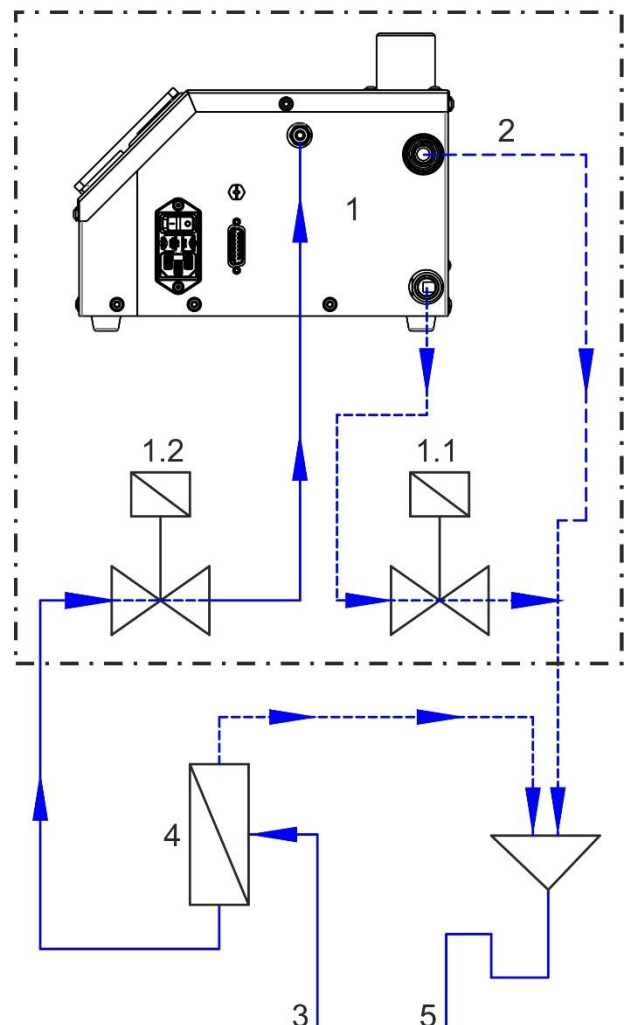

Fig. 30 - Schema AquaDrain

14.2 Features

14.2.1 Flushing of water supply line

The humidifier goes into flushing mode, which is carried out in two phases depending on the time, for the following events:

1. Initial start-up (operating voltage is present for the first time)
2. Operating voltage is applied again (after each interruption of operation voltage)
3. After each humidifying pause which is longer than the AquaDrain cycle

The first phase includes the actual flushing process. The solenoid inlet and drainage valves are opened at the same time for 30 seconds. The water supply pipes and/or tubes are rinsed. This ensures that the **FIRST** water present in the supply line (possibly hygienically questionable) is not atomised as it is drained directly without filling up the fluid tank. The flushing volume depends on the pressure of the demineralised water (Fig. 35) and the flush time (Tab. 13-1).

In the second phase the solenoid valve supply is closed again. The solenoid valve drain remains open for another 3 min. to ensure that the water that might still be inside the fluid tank is drained.

If a humidification request is made after the two-phase rinse operation, the humidifier will go into normal operation. At the same time, the solenoid valve supply opens and the solenoid valve drain closes. The fluid tank is filled up to maximum level. After that, provided that all internal and external safety elements allow for operation, humidification starts.

The filling time for the fluid tank of the humidifier is determined by the pressure of the demineralised water.

If no humidification request follows after the two-phase rinse operation, the humidifier will go into standby mode until a humidification request is carried out.

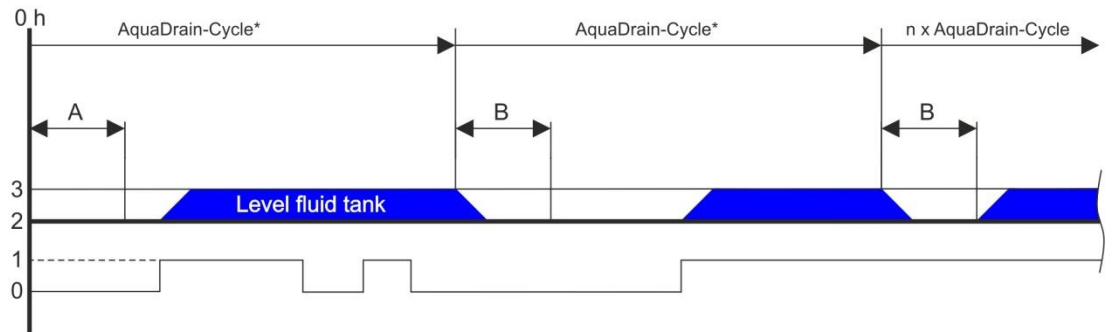

Fig. 31 - Example for commissioning and restart

Definitions

*) possible AquaDrain-Cycles: 10 Min., 30 Min., 1.5 h, 3 h, 6 h, 12 h, 24 h and 48 h (default 12 h, may be changed in the factory upon request)

- 0) Humidity request OFF
- 1) Humidity request ON
- 2) Fluid tank empty
- 3) Fluid tank full

- A) Flushing of water supply line
- B) Drainage of fluid tank

	Any humidification request made during the rinse operation will be ignored.
--	---

14.2.2 Drainage of fluid tank

The humidifier is cyclically drained every 12 hours, if humidification took place in the last AquaDrain cycle and in case of any power interruption in the AquaDrain cycle (operating voltage is no longer present).

	<p>Any humidification request made during the drainage process will be ignored.</p>
---	---

If no humidification is requested, the humidifier is in standby mode.

If the fluid tub is still full, it will be automatically emptied after the adjustable "Inactivity Drain Timeout", see Tab. 13-1. For optional factory settings, see chapter 13.4.

If the system is drained, the fluid tank will only be refilled, when a humidification request was made.

Time of AquaDrain Duration see Tab. 13-1.

The filling time for the fluid tank of the humidifier is determined by the pressure of the demineralised water.

The fluid tank will stay dry, if there is no humidification request.

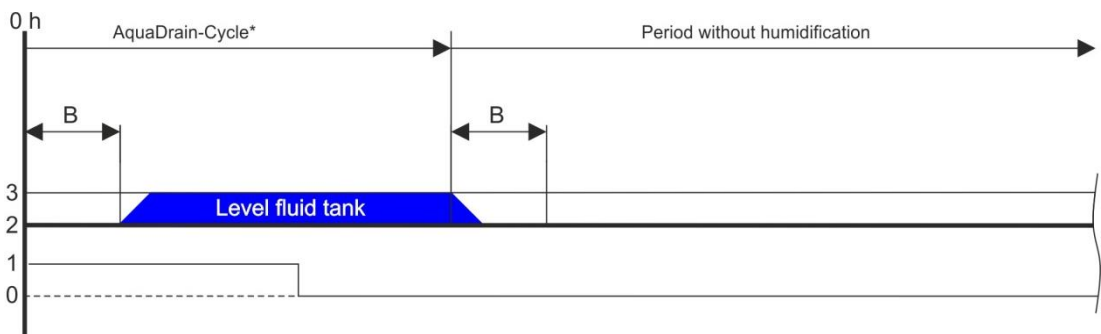

Fig. 32 - Example for period without humidification

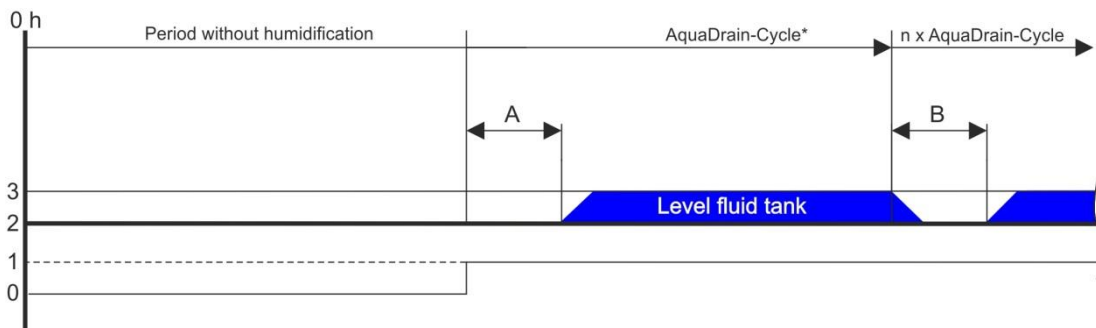

Fig. 33 - Example for new humidification request

- A) Flushing of water supply line
- B) Drainage of fluid tank

14.3 AquaDrain diagrams

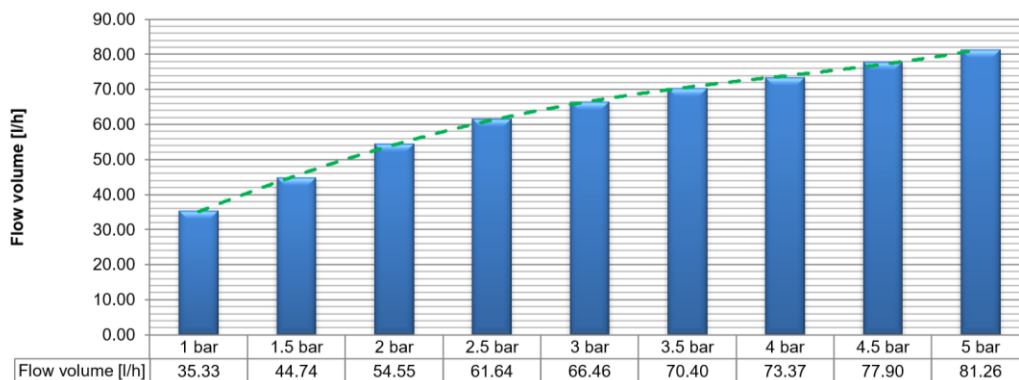

Fig. 34 - Flow volume inlet solenoid valve ND 1.2 mm depending on waterpressure

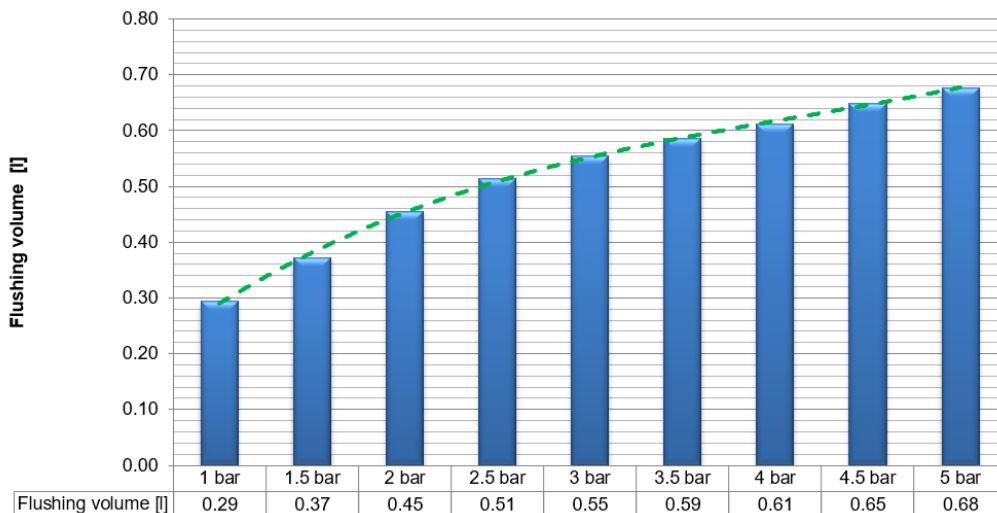

Fig. 35 - Flushing volume at a flushing time of 30 s depending on the water pressure in liters

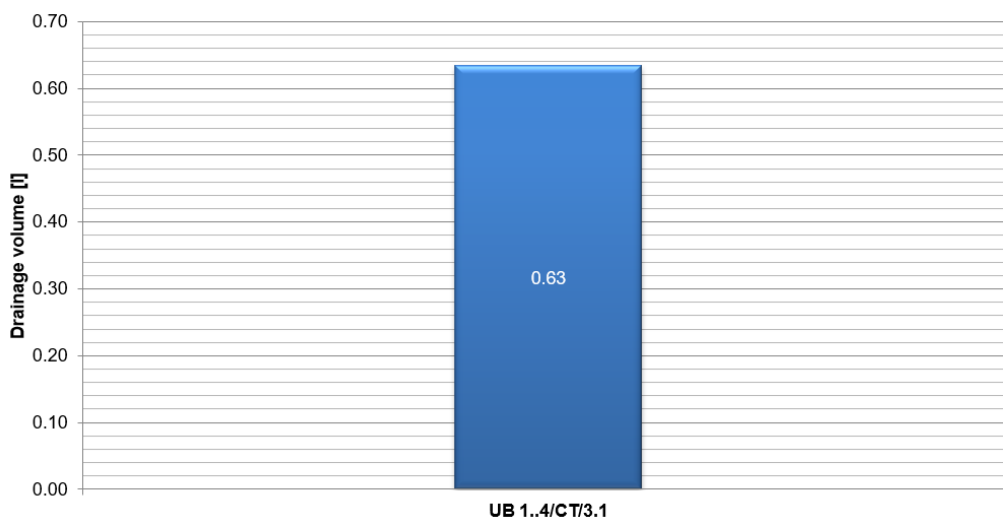

Fig. 36 - Drainage volume - fluid tank UB-1...4/3.1

15. Commissioning

Before commissioning the humidifier, check once again that all installation and wiring work has been carried out correctly and fully completed. In particular, the water and power supply connections must be in proper order and comply with the relevant safety regulations.

15.1 Manual functions

- Release of permeat inlet into the humidifier

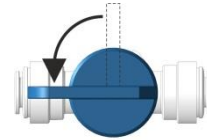

Fig. 37 - Stop cock

- • Release of 230 V / 50 Hz to the transformer and switch on transformer



Fig. 38 - Circuit breaker

- Switch on humidifier (The control lamp lights up GREEN)

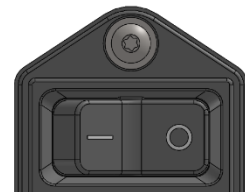

Fig. 39 - ON/OFF switch

- The SET humidity at the continuous control must be higher than the ACTUAL humidity



Fig. 40 - Continuous controller CT1

- Set set point higher than the ACTUAL humidity

15.2 Automatic functions

- *Flushing of water supply line:*

The solenoid valve supply of the humidifier opens. The solenoid valve drain is open. The water supply line is flushed without the fluid tank of the humidifier being filled.

	The feature "Flushing of water supply line" does not replace flushing of the newly established water inlet pipe. Flushing only changes the demineralised water (which may be hygienically questionable) in the supply line.
---	---

The solenoid valve supply closes. The solenoid valve drain stays open for 180 seconds.

- *Filling the fluid tank:*

The solenoid valve drain closes. The solenoid valve supply opens. The fluid tank of the humidifier is filled. The water level is automatically controlled within narrow tolerances. Internal safety monitoring of the water temperature and dry running protection is done automatically.

	The fluid tank may only be filled if a humidification request has been made. Otherwise the fluid tank of the humidifier will remain dry.
--	--

- *Humidification:*

Once the maximum water level is reached and the humidification request is still present, humidification will start.

15.3 Make applied settings

- *Adjust set point value for humidity.*

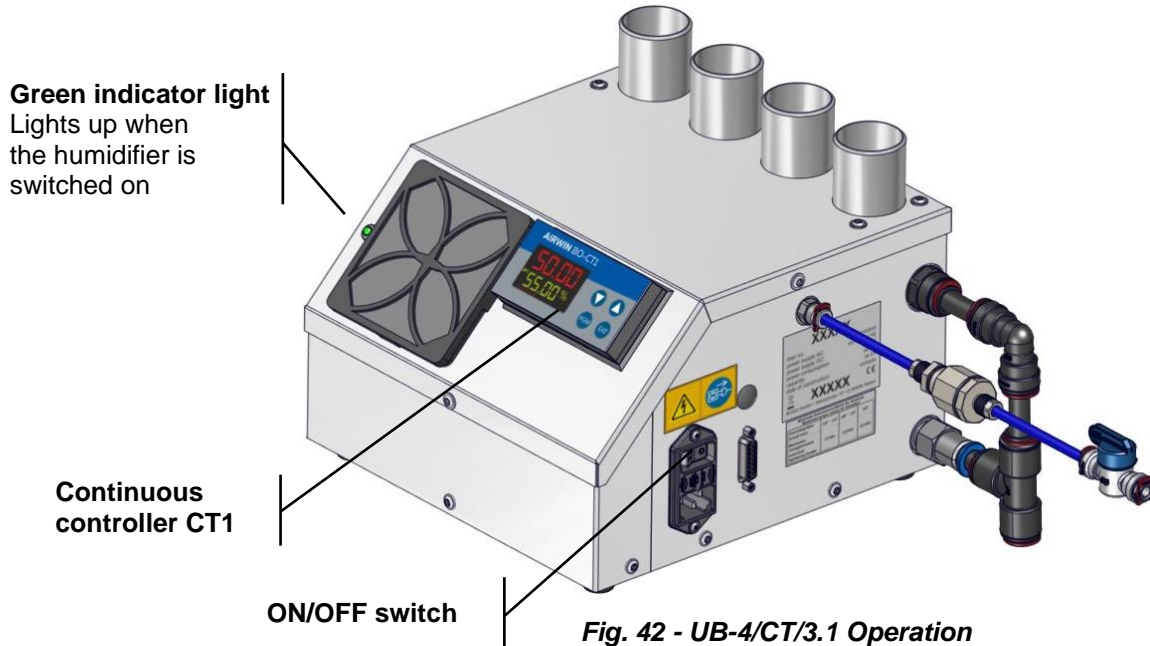

Fig. 41 - Continuous controller CT1

Commissioning of the humidifier is completed.

16. Operation

If the supply voltage and the water supply are present, the ON / OFF switch in the housing wall of the humidifier must be switched to "I" to start up. As soon as there is a humidification request, the humidifier starts humidifying operation.



17. Technical data

Tab. 17-1 - Specifications

Specifications		UB-1/CT/3.1	UB-2/CT/3.1	UB-3/CT/3.1	UB-4/CT/3.1
Air humidification output*	kg/h	0.5	1.0	1.5	2.0
Transducer	Unit	1	2	3	4
Power supply	V / 50 Hz	230	230	230	230
Power consumption	VA / 50 Hz	100	130	160	190
Fuse rating	A	2.5 T	2.5 T	2.5 T	2.5 T
Fan performance **	m ³ /h	120	120	120	120

* The humidifying performance depends on the length and the cross-section of the pipes/hoses leading to the place of humidification. See Chapter 10: Aerosol distribution systems

** The fan performance depends on the length of the pipes/tubes, the way they were installed and their diameters. The double fan only increases compression, not the volume of the air. See Chapter 10: Aerosol distribution systems

Tab. 17-2 - Safety devices

Safety devices	Description
Dry-running protection with functional redundancy	If the water level falls below the minimum level in the fluid tank, the humidification switches off. For this purpose, both level switches are monitored separately.
Overheating protection	The humidifier stops humidifying at water temperatures > 60 °C.
Overflow protection	If the humidifier fluid tank is overfilled, the excess water is drained off to the outside through the overflow.
Disconnect protection	There are no defects in the event of electrical interruptions between the oscillator board and the transducer.
Monitoring	Monitoring of important system components with integrated problem solver routines.

Tab. 17-3 - Operation conditions

Operation conditions	Parameter
Maximum air humidity	< 90 % relative humidity – no condensation!
Air temperature	5 - 45 °C
Demineralised water pressure	1 - 4 bar
Demineralised water quality	fully demineralised
Demineralised water conductivity	5 - 20 µS/cm

18. Equipment dimensions / weights

UB-1/CT/3.1 to UB-4/CT/3.1

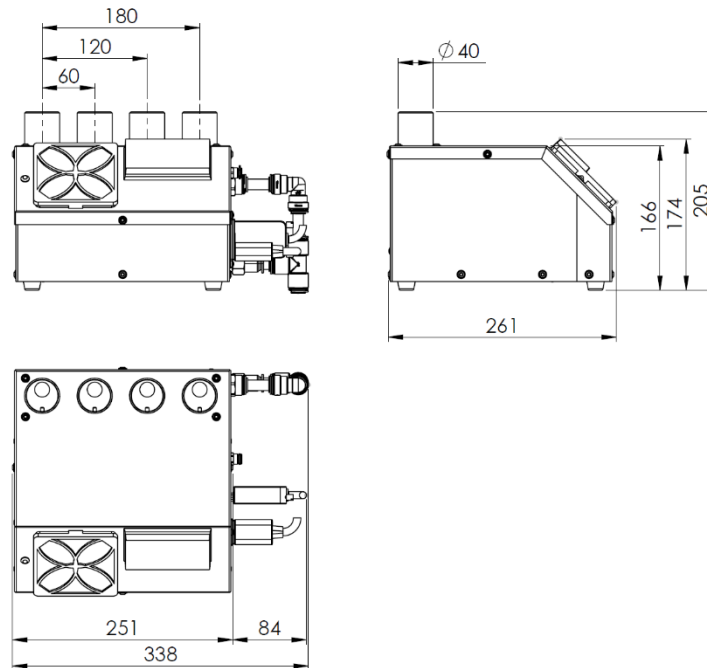

Fig. 43 - UB-4/CT/3.1 dimensions and weights

Tab. 17.1

Spezifikation	Einheit	UB-1/CT/3.1	UB-2/CT/3.1	UB-3/CT/3.1	UB-4/CT/3.1
Gewicht	kg	7,7	7,8	7,9	8,0

19. Circuit diagrams

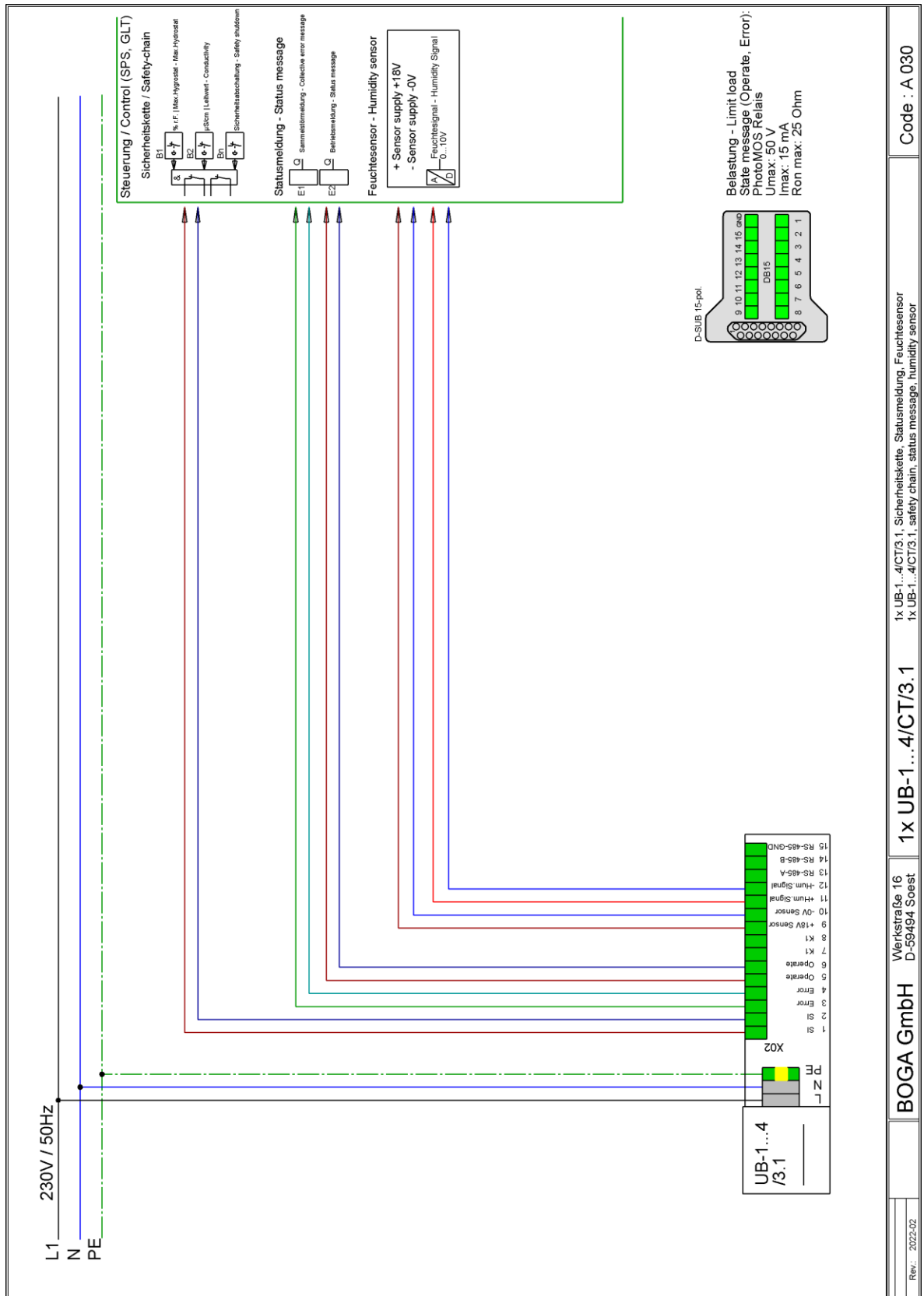

Fig. 44 - 1x UB-1/CT/3.1 bis UB-4/CT/3.1 - safety chain, status message, control voltage

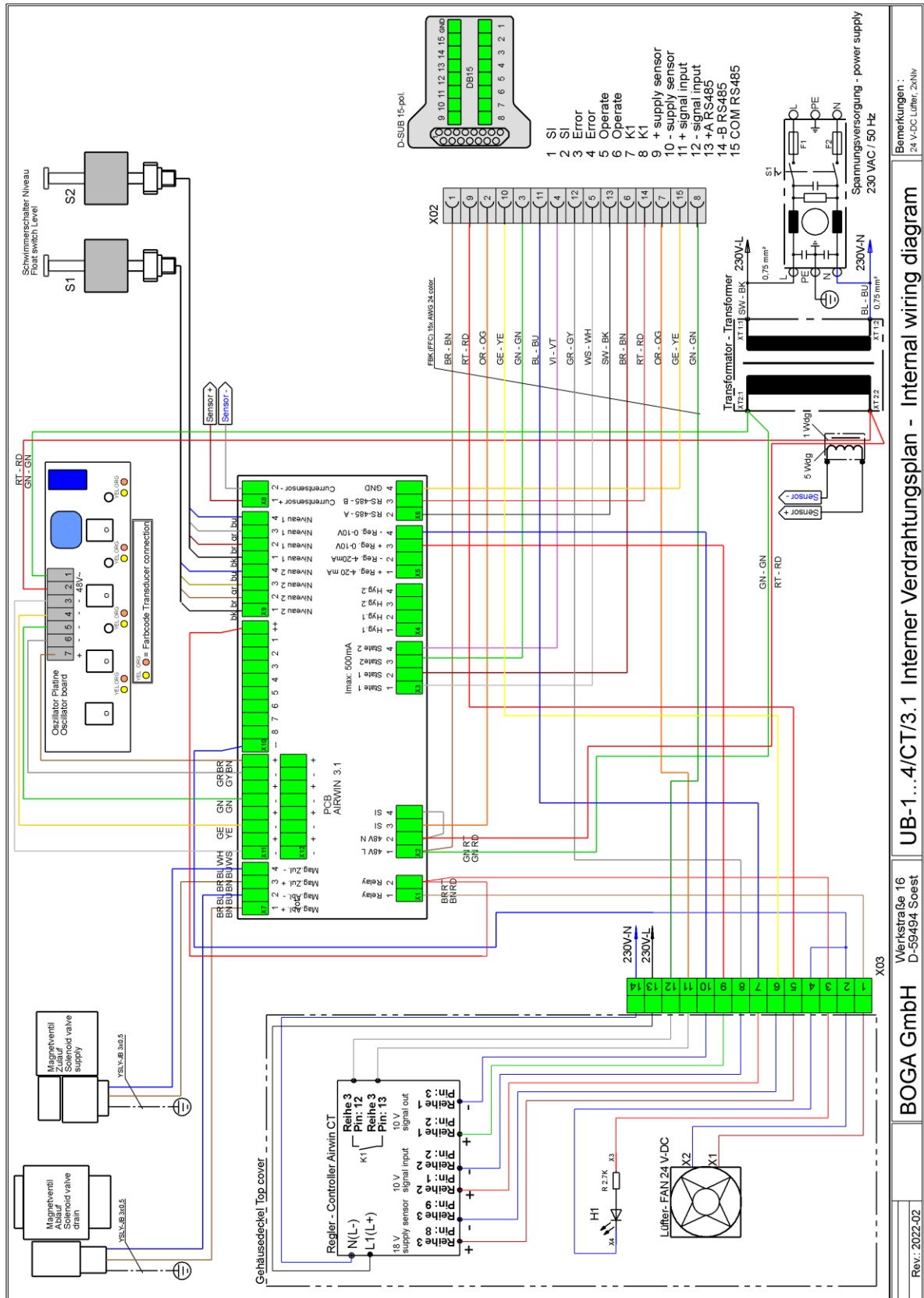



Fig. 45 - Internal wiring diagram UB-1/CT/3.1 to UB-4/CT/3.1

20. Care

It is essential that the humidifier is easy to inspect and easily accessible on site.

	Good accessibility and exchangeability of the humidifier save costs!
---	--

Prior to opening the humidifier, it must be disconnected from the electricity and water supply.

Then unscrew the cover screws and remove the cover. In case of pollution, the fluid tank of the humidifier must be cleaned by using a clean, medium hard brush and clean water. The transducers must be wiped clean with a soft, scratch-free cloth. Incrustations or solid deposits on the transducers must be carefully removed. For that purpose, it is recommended to use 20% formic acid.

	Deposits are a direct consequence of inadequate water quality!
---	--

The finger guard of the radial fan with the inner fleece is removable. The fleece can be cleaned in a warm washing solution.

The care intervals depend on the respective degree of contamination of the humidifier. It depends directly on the cleanliness of the intake air and the feed water quality. It may be necessary to perform care at shorter intervals.

For better filtering of extremely polluted intake air, an additional filter box is recommended (see optional accessories).

The performance of the ultrasonic transducers decreases with actual operating hours. The life time of the ultrasonic transducers will be shortened by unfavourable operating conditions e.g. water and air pollution or overvoltage.

Tab. 20-1 - Care and cleaning

Care and cleaning tasks	
1. Checks	
<p>Check the fluid tank, the transducers and the intake air filter for contamination. → Clean them, if necessary!</p>	<p>Initially, a check has to be carried out after 1 week. Depending on the degree of contamination of the fluid tank, the transducers and the intake air filter, the cleaning intervals must be adjusted.</p>
	<p>If pollution is found during the check, cleaning must be performed.</p>
2. Care and cleaning	
<p>- Fluid tank - Transducers - Intake air filter</p>	<p>Slime in the fluid tank is a sign of the presence of micro-organisms! Cause: Air and/or water</p> <p>Incrustations are mineral deposits! Cause: Water</p>
Measures	<ul style="list-style-type: none"> • Check and clean the environment, if required! • Retrofit filter box (optional accessories) • Check reverse osmosis system! • Adjust cleaning intervals!
	<p>Even without visible pollution, cleaning must be done at least every 12 months.</p>

21. Standards

21.1 EC declaration of conformity according to Machinery directive 2006/42/EC, Annex II 1.A

The manufacturer BOGA GmbH, Werkstraße 16, D-59494 Soest, hereby declares that the following product

Product designation:	Universal Humidifier
Make:	AIRWIN
Series/type designation:	UB-1/CT/3.1 UB-2/CT/3.1 UB-3/CT/3.1 UB-4/CT/3.1

fulfills all the relevant provisions of the directive specified above and the additionally applied directives (in the following) - including the changes which applied at the time of the declaration.

The following additional EU directives have been applied:
EMC Directive 2014/30/EU
RoHS directive 2011/65/EU

The protection objectives of the Low-Voltage Directive 2014/35/EU have been observed.

The series complies with the safety regulations of VDE 0100 and was tested in accordance with VDE 701 part 1.

21.2 WEEE

The humidifier is WEEE-registered.

21.3 Legal notice - Copyright

Legal notice

BOGA GmbH
Gesellschaft für moderne Gerätetechnik
Werkstraße 16
D-59494 Soest
Telefon : +49 2921 96943-0
Telefax : +49 2921 96943-29
E-Mail : info@boga.de
Internet : www.boga.de

Copyright

The copyright and all other rights of use for the documents belong to BOGA GmbH. The documents may not be copied, distributed, publicly displayed, edited or otherwise transformed without the written consent of BOGA GmbH.

22. List of figures

Fig. 1 - Schematic sketch of piezo-effect	8
Fig. 2 - Schematic sketch aerosol production	9
Fig. 3 - UB-4/CT/3.1 Overview	11
Fig. 4 - Schematic illustration of UB-4/CT/3.1 humidification system	12
Fig. 5 - Aerosol Jet	14
Fig. 6 - Cross-section of aerosol jet	14
Fig. 7 - UB-4/CT/3.1 with pipes for aerosol transport	15
Fig. 8 - UB-4/CT/3.1 with joined aerosol outlets	15
Fig. 9 - Schematic diagram of hydraulic conditions	16
Fig. 10 - Establishing the connection	17
Fig. 11 - Insert tube	17
Fig. 12 - Check connection	17
Fig. 13 - Detaching the connection	17
Fig. 14 - Electric connection	18
Fig. 15 - 15-pole D-SUB connector	18
Fig. 16 - Safety chain	20
Fig. 17 - PhotoMOS Relais	20
Fig. 18 - BO-FWL room humidity transmitter	21
Fig. 19 - Continuous controller CT1	22
Fig. 20 - Configuration level	22
Fig. 21 - Parameter level	23
Fig. 22 - Self-optimisation	24
Fig. 23 - Start self-optimisation	24
Fig. 24 - Control board PCB AIRWIN 3.1 Input	25
Fig. 25 - Control board PCB AIRWIN 3.1 Outputs	26
Fig. 26 - State diagram	31
Fig. 27 - Control board AIRWIN 3.1	32
Fig. 28 - Decoding LED-Display	33
Fig. 29 - Levelswitch S2	33
Fig. 30 - Schema AquaDrain	35
Fig. 31 - Example for commissioning and restart	37
Fig. 32 - Example for period without humidification	38
Fig. 33 - Example for new humidification request	38
Fig. 34 - Flow volume inlet solenoid valve ND 1.2 mm depending on waterpressure	39
Fig. 35 - Flushing volume at a flushing time of 30 s depending on the water pressure in liters	39
Fig. 36 - Drainage volume - fluid tank UB-1...4/3.1	39
Fig. 37 - Stop cock	40
Fig. 38 - Circuit breaker	40
Fig. 39 - ON/OFF switch	40
Fig. 40 - Continuous controller CT1	40
Fig. 41 - Continuous controller CT1	41
Fig. 42 - UB-4/CT/3.1 Operation	42
Fig. 43 - UB-4/CT/3.1 dimensions and weights	44
Fig. 44 - 1x UB-1/CT/3.1 bis UB-4/CT/3.1 - safety chain, status message, control voltage	45
Fig. 45 - Internal wiring diagram UB-1/CT/3.1 to UB-4/CT/3.1	46



23. List of tables

Tab. 11-1 - Connection diagram plug D-SUB 15-pin	19
Tab. 11-2 - Status messages operation / error	20
Tab. 11-3 - Connection of the BO-FWL.....	21
Tab. 13-1 - Default settings PCB AIRWIN 3.1	28
Tab. 13-2 - Status messages - System States.....	32
Tab. 13-3 - Troubleshooting checklist	34
Tab. 17-1 - Specifications.....	43
Tab. 17-2 - Safety devices	43
Tab. 17-3 - Operation conditions.....	43
Tab. 20-1 - Care and cleaning.....	48